

# MODEL NAH-720-1 PERFORMANCE DATA

## Imperial Units (Forward Flow)

Damper Width X Height	1 in. w.g. Class	4 in. w.g. Class	8 in. wg Class	*Torque (per sq. ft.)
12" x 12"	Class I	Class II	Class II	15 lbs/in
24" X 24"	Class I	Class I	Class I	12.59 lbs/in
36" X 36"	Class I	Class I	Class I	15 lbs/in
12" X 48"	Class III	Class III	Class II	12.59 lbs/in
48" X 12"	Class I	Class I	Class I	12.59 lbs/in
60" X 36"	Class II	Class II	Class II	15 lbs/in

Air leakage is based on operation between 50°F to 104°F. All data corrected to represent air density of 0.075 lbs/ft.<sup>3</sup>

\*Torque applied to hold damper in closed position

## Imperial Units (Back Flow)

Damper Width X Height	1 in. w.g. Class	4 in. w.g. Class	8 in. wg Class	*Torque (per sq. ft.)
12" x 12"	Class II	Class III	Class III	15 lbs/in
24" X 24"	Class I	Class I	Class II	12.59 lbs/in
36" X 36"	Class II	Class III	Class III	15 lbs/in
12" X 48"	Class III	Class III	Class III	12.59 lbs/in
48" X 12"	Class II	Class II	Class II	12.59 lbs/in
60" X 36"	Class III	Class III	Class II	15 lbs/in

\*Torque applied to hold damper in closed position

		Leakage, ft <sup>3</sup> /min <sup>2</sup> /ft			
		Required Rating		Extended Ranges (optional)	
Class	Pressure	1"	4"	8"	12"
		I	4	8	11
II	10	20	28	35	
III	40	80	112	140	

All data corrected to represent standard air at a density of 0.075 lbs/ft.

NAH-720 SOUND RATINGS								
Damper Size	Damper Full Open		Damper 75% Open		Damper 50% Open		Damper 25% Open	
	CFM	NC	CFM	NC	CFM	NC	CFM	NC
12 x 12	2000	16	1500	11	1000	11	500	*
	3000	28	2250	21	1500	18	750	*
	4000	36	3000	29	2000	24	1000	*
18 x 18	2250	17	1688	10	1125	21	563	*
	4500	33	3375	26	2250	31	1125	*
	6750	43	5063	37	3375	40	1688	15
24 x 24	4000	11	3000	10	2000	26	1000	*
	8000	33	6000	29	4000	37	2000	21
	12000	43	9000	42	6000	46	3000	31

NC = Noise criteria in Decibels is based on room effect and 10db of room attenuation.  
\* = Less than 10 NC

3

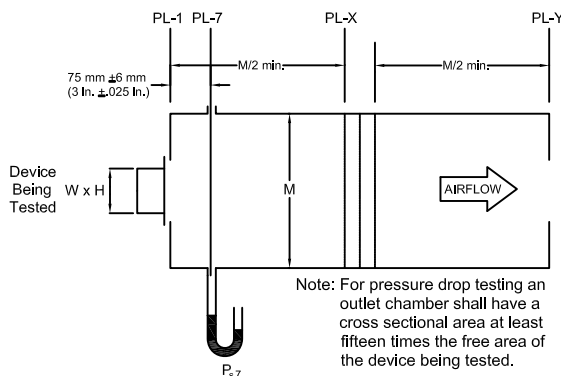

Figure 5.4- Test Device Setup with Outlet Chamber

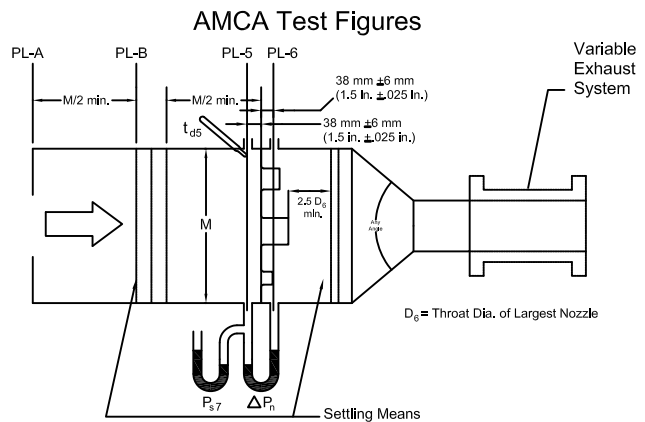

Figure 6.3- Airflow Rate Measurement Setup- Multiple Nozzle Chamber on Fan Inlet

# MODEL NAH-720-1 PERFORMANCE DATA

## Standard International Units (Forward Flow)

Damper Width X Height (mm)	250 Pa Class	1 KPa Class	2 KPa Class	*Torque
305 x 305	Class I	Class II	Class II	2,679 grams/cm
610 X 610	Class I	Class I	Class I	2,248 grams/cm
915 X 915	Class I	Class I	Class I	2,679 grams/cm
305 X 1220	Class III	Class III	Class II	2,248 grams/cm
1220 X 305	Class I	Class I	Class I	2,248 grams/cm
1525 X 915	Class II	Class II	Class II	2,679 grams/cm

Air leakage is based on operation between 10°C to 40°C. All data corrected to represent air density of 1.201 kg/m<sup>3</sup>

\*Torque applied to hold damper in closed position

## Standard International Units (Back Flow)

Damper Width X Height (mm)	250 Pa Class	1 KPa Class	2 KPa Class	*Torque
305 x 305	Class II	Class III	Class III	2,679 grams/cm
610 X 610	Class I	Class I	Class II	2,248 grams/cm
915 X 915	Class II	Class III	Class III	2,679 grams/cm
305 X 1220	Class III	Class III	Class III	2,248 grams/cm
1220 X 305	Class II	Class II	Class II	2,248 grams/cm
1525 X 915	Class III	Class III	Class II	2,679 grams/cm

\*Torque applied to hold damper in closed position

		Leakage, L/s /m <sup>2</sup>			
		Required Rating		Extended Ranges (optional)	
Class	Pressure	0.25 kPa	1.0 kPa	2.0 kPa	3.0 kPa
I		20.3	40.6	55.9	71.1
II		50.8	102	142	178
III		203	406	569	711

## FRAME & BOLT HOLE CONSTRUCTION OPTIONS

Flange (F Dim): Standard - 2"  
Optional - 1-1/2" to 4"

Bolt holes: (Standard construction is **no** bolt holes)

Web (D Dim): Standard - 8"  
Optional - 8" to 12"

Dim. "M": 7/16" dia. hole  
Dim. "L": 6" Center to Center

**Note:** Customer must be within Min. or Max limits on table below.

Dim.	Min or Max	Standard	Description
<b>J</b>	min. 3/4"		First/Last Space in <b>Head/Sill</b>
<b>N1</b>	min. 1.0"		No. of holes in <b>Head/Sill</b>
<b>K</b>	min. F/2"		First/Last Space in <b>Jamb</b>
<b>N2</b>	min. 1.0"		No. of holes in <b>Jamb</b>
<b>C</b>	.75*D" to 3/4"	F/(2*M)"	Centerline of bolt hole from inside edge of frame
<b>L</b>	2" to 12"	6.0"	Hole Spacing
<b>M</b>	1/4" to 11/16"	7/16"	Mounting hole Diameter

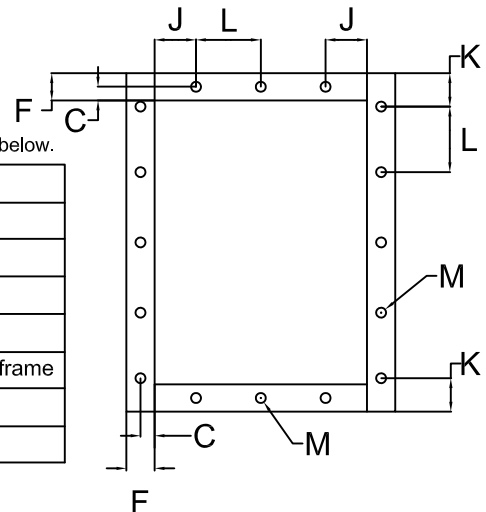

# MODEL NAH-720-1 PERFORMANCE DATA

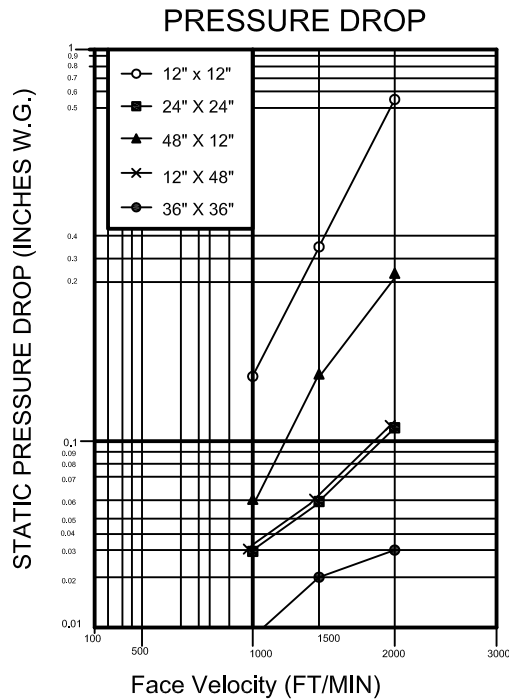

NAH-720-1 sizes: 12x12, 24x24, 48x12, 12x48, 36x36  
(305x305, 610x610, 1219x305, 305x1219, 914x914)

#### NAH-720-1

#### PRESSURE LIMITATIONS

The chart at the right shows conservative pressure limitations based on a maximum blade deflection of  $w/360$ .

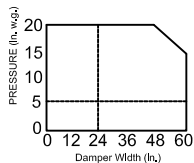

#### TEMPERATURE LIMITATIONS

Blade Seals: EPDM  $-40^{\circ}$  to  $+250^{\circ}$ F  
Silicone Rubber  $-40^{\circ}$  to  $+450^{\circ}$ F  
Jamb Seals: Flexible stainless steel  $-40^{\circ}$  to  $+400^{\circ}$ F

#### VELOCITY LIMITATIONS

The chart at the right shows conservative velocity limitations based on damper size.

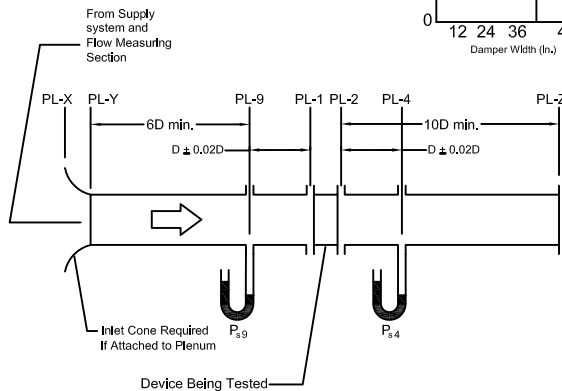
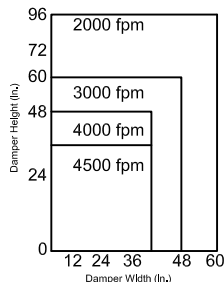

Figure 5.3- Test Device Setup with Inlet and Outlet Ducts

#### AMCA Test Figure 5.3

Figure 5.3 illustrates a fully ducted damper. This configuration has low pressure drop because entrance and exit losses are minimized by straight duct runs upstream and downstream of the damper.

#### Pressure Drop Data

This pressure drop data was conducted in accordance with AMCA Standard 500 using Test Figure 5.3. All data has been corrected to represent standard air at a density of .075 lb/cu.ft.

Actual pressure drop found in any HVAC system is a combination of many factors. This pressure drop information along with an analysis of other system influences should be used to estimate actual pressure losses for a damper installed in a given HVAC system.

12 x 12	
Face Velocity ft/min (m/s)	Pressure Drop in. w.g. (Pa)
1000 (5.08)	0.15 (38)
1500 (7.62)	0.33 (83)
2000 (10.16)	0.55 (139)

24 x 24	
Face Velocity ft/min (m/s)	Pressure Drop in. w.g. (Pa)
1000 (5.08)	0.03 (7)
1500 (7.62)	0.06 (15)
2000 (10.16)	0.11 (27)

48 x 12	
Face Velocity ft/min (m/s)	Pressure Drop in. w.g. (Pa)
1000 (5.08)	0.06 (15)
1500 (7.62)	0.15 (38)
2000 (10.16)	0.23 (58)

12 x 48	
Face Velocity ft/min (m/s)	Pressure Drop in. w.g. (Pa)
1000 (5.08)	0.03 (7)
1500 (7.62)	0.06 (15)
2000 (10.16)	0.11 (27)

36 x 36	
Face Velocity ft/min (m/s)	Pressure Drop in. w.g. (Pa)
1000 (5.08)	0.009 (2)
1500 (7.62)	0.02 (5)
2000 (10.16)	0.03 (7)

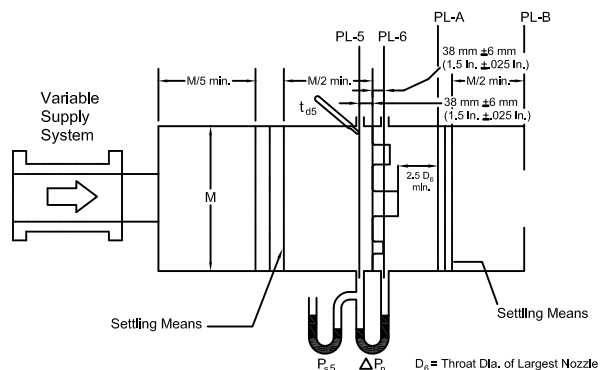

Figure 6.5- Airflow Rate Measurement Setup- Multiple Nozzle Chamber on Fan Outlet

# MODEL NAH-720-2 PERFORMANCE DATA

## Imperial Units (Forward Flow)

Damper Width X Height	1 in. w.g. Class	4 in. w.g. Class	8 in. wg Class	*Torque (per sq. ft.)
12" x 12"	Class I	Class II	Class II	15 lbs/in
24" X 24"	Class I	Class I	Class I	12.59 lbs/in
36" X 36"	Class I	Class I	Class I	15 lbs/in
12" X 48"	Class III	Class III	Class II	12.59 lbs/in
48" X 12"	Class I	Class I	Class I	12.59 lbs/in
60" X 36"	Class II	Class II	Class II	15 lbs/in

Air leakage is based on operation between 50°F to 104°F. All data corrected to represent air density of 0.075 lbs/ft.<sup>3</sup>

\*Torque applied to hold damper in closed position

## Imperial Units (Back Flow)

Damper Width X Height	1 in. w.g. Class	4 in. w.g. Class	8 in. wg Class	*Torque (per sq. ft.)
12" x 12"	Class II	Class III	Class III	15 lbs/in
24" X 24"	Class I	Class I	Class II	12.59 lbs/in
36" X 36"	Class II	Class III	Class III	15 lbs/in
12" X 48"	Class III	Class III	Class III	12.59 lbs/in
48" X 12"	Class II	Class II	Class II	12.59 lbs/in
60" X 36"	Class III	Class III	Class II	15 lbs/in

\*Torque applied to hold damper in closed position

		Leakage, ft <sup>3</sup> /min <sup>2</sup> /ft			
		Required Rating		Extended Ranges (optional)	
Class	Pressure	1"	4"	8"	12"
	I		4	8	11
II		10	20	28	35
III		40	80	112	140

All data corrected to represent standard air at a density of 0.075 lbs/ft.

NAH-720 SOUND RATINGS								
Damper Size	Damper Full Open		Damper 75% Open		Damper 50% Open		Damper 25% Open	
	CFM	NC	CFM	NC	CFM	NC	CFM	NC
12 x 12	2000	16	1500	11	1000	11	500	*
	3000	28	2250	21	1500	18	750	*
	4000	36	3000	29	2000	24	1000	*
18 x 18	2250	17	1688	10	1125	21	563	*
	4500	33	3375	26	2250	31	1125	*
	6750	43	5063	37	3375	40	1688	15
24 x 24	4000	11	3000	10	2000	26	1000	*
	8000	33	6000	29	4000	37	2000	21
	12000	43	9000	42	6000	46	3000	31

NC = Noise criteria In Decibels Is based on room effect and 10db of room attenuation.  
\* = Less than 10 NC

## AMCA Test Figures

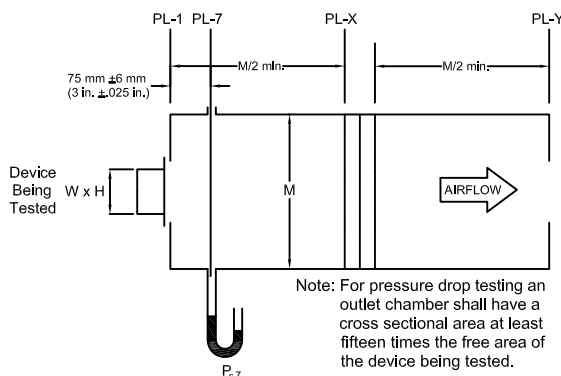

Figure 5.4- Test Device Setup with Outlet Chamber

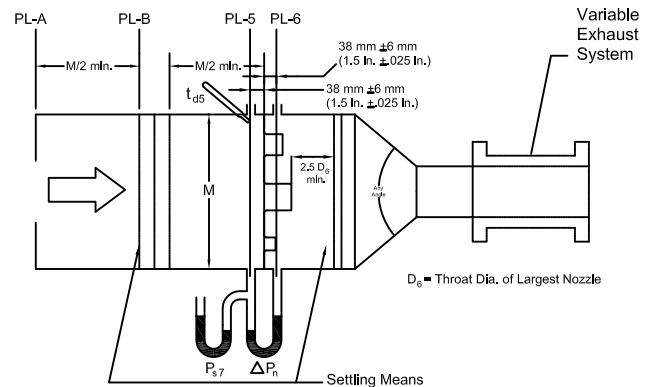

Figure 6.3- Airflow Rate Measurement Setup- Multiple Nozzle Chamber on Fan Inlet

# MODEL NAH-720-2 PERFORMANCE DATA

## Standard International Units (Forward Flow)

Damper Width X Height (mm)	250 Pa Class	1 KPa Class	2 KPa Class	*Torque
305 x 305	Class I	Class II	Class II	2,679 grams/cm
610 X 610	Class I	Class I	Class I	2,248 grams/cm
915 X 915	Class I	Class I	Class I	2,679 grams/cm
305 X 1220	Class III	Class III	Class II	2,248 grams/cm
1220 X 305	Class I	Class I	Class I	2,248 grams/cm
1525 X 915	Class II	Class II	Class II	2,679 grams/cm

Air leakage is based on operation between 10°C to 40°C. All data corrected to represent air density of 1.201 kg/m<sup>3</sup>.

\*Torque applied to hold damper in closed position

## Standard International Units (Back Flow)

Damper Width X Height (mm)	250 Pa Class	1 KPa Class	2 KPa Class	*Torque
305 x 305	Class II	Class III	Class III	2,679 grams/cm
610 X 610	Class I	Class I	Class II	2,248 grams/cm
915 X 915	Class II	Class III	Class III	2,679 grams/cm
305 X 1220	Class III	Class III	Class III	2,248 grams/cm
1220 X 305	Class II	Class II	Class II	2,248 grams/cm
1525 X 915	Class III	Class III	Class II	2,679 grams/cm

\*Torque applied to hold damper in closed position

Class	Leakage, L/s /m <sup>2</sup>			
	Required Rating		Extended Ranges (optional)	
	0.25 kPa	1.0 kPa	2.0 kPa	3.0 kPa
I	20.3	40.6	55.9	71.1
II	50.8	102	142	178
III	203	406	569	711

## FRAME CONSTRUCTION OPTIONS

Flange (F Dim): Standard - 2"  
Optional - 1-1/2" to 4"

Bolt holes: (Standard construction is **no** bolt holes)

Web (D Dim): Standard - 8"  
Optional - 8" to 12"

Dim. "M": 7/16" dia. hole  
Dim. "L": 6" Center to Center

**Note:** Customer must be within Min. or Max limits on table below.

Dim.	Min or Max	Standard	Description
<b>J</b>	min. 3/4"		First/Last Space in <b>Head/Sill</b>
<b>N1</b>	min. 1.0"		No. of holes in <b>Head/Sill</b>
<b>K</b>	min. F/2"		First/Last Space in <b>Jamb</b>
<b>N2</b>	min. 1.0"		No. of holes in <b>Jamb</b>
<b>C</b>	.75*D" to 3/4"	F/(2*M)"	Centerline of bolt hole from inside edge of frame
<b>L</b>	2" to 12"	6.0"	Hole Spacing
<b>M</b>	1/4" to 11/16"	7/16"	Mounting hole Diameter

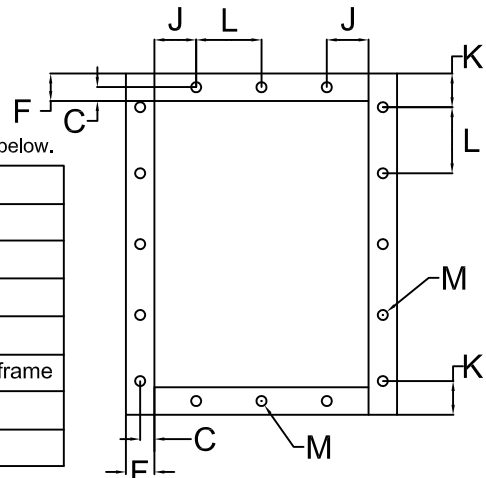

# MODEL NAH-720-2 PERFORMANCE DATA

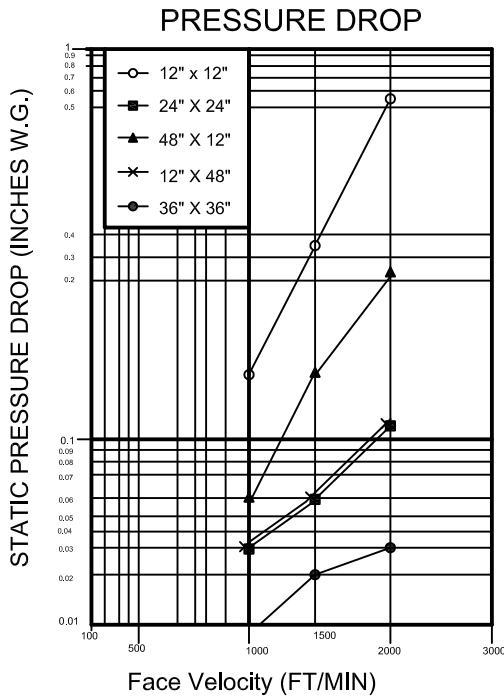

Based on STANDARD AIR- .075 lb. per cubic foot.

NAH-720-2 sizes: 12x12, 24x24, 48x12, 12x48, 36x36  
 (305x305, 610x610, 1219x305, 305x1219, 914x914)

#### NAH-720-2

#### PRESSURE LIMITATIONS

The chart at the right shows conservative pressure limitations based on a maximum blade deflection of  $w/360$ .

#### TEMPERATURE LIMITATIONS

Blade Seals: EPDM  $-40^{\circ}$  to  $+250^{\circ}$ F  
 Silicone Rubber  $-40^{\circ}$  to  $+450^{\circ}$ F  
 Jamb Seals: Flexible stainless steel  $-40^{\circ}$  to  $+400^{\circ}$ F

#### VELOCITY LIMITATIONS

The chart at the right shows conservative velocity limitations based on damper size.

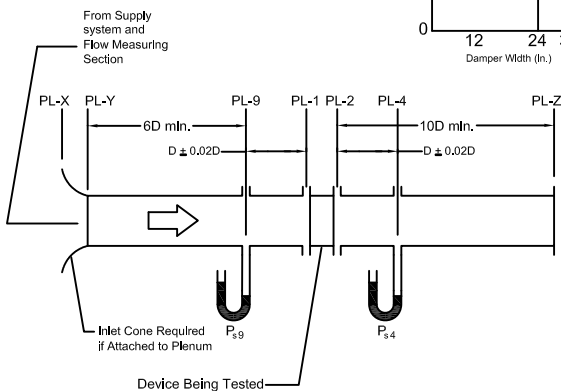
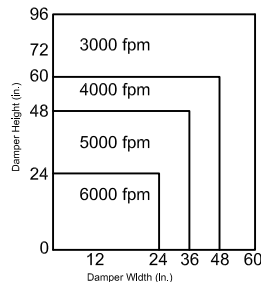
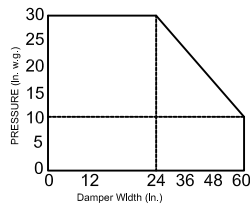

Figure 5.3- Test Device Setup with Inlet and Outlet Ducts

#### AMCA Test Figure 5.3

Figure 5.3 illustrates a fully ducted damper. This configuration has low pressure drop because entrance and exit losses are minimized by straight duct runs upstream and downstream of the damper.

#### Pressure Drop Data

This pressure drop data was conducted in accordance with AMCA Standard 500 using Test Figure 5.3. All data has been corrected to represent standard air at a density of .075 lb/cu.ft.

Actual pressure drop found in any HVAC system is a combination of many factors. This pressure drop information along with an analysis of other system influences should be used to estimate actual pressure losses for a damper installed in a given HVAC system.

#### 12 x 12

Face Velocity ft/min (m/s)	Pressure Drop in. w.g. (Pa)
1000 (5.08)	0.15 (38)
1500 (7.62)	0.33 (83)
2000 (10.16)	0.55 (139)

#### 24 x 24

Face Velocity ft/min (m/s)	Pressure Drop in. w.g. (Pa)
1000 (5.08)	0.03 (7)
1500 (7.62)	0.06 (15)
2000 (10.16)	0.11 (27)

#### 48 x 12

Face Velocity ft/min (m/s)	Pressure Drop in. w.g. (Pa)
1000 (5.08)	0.06 (15)
1500 (7.62)	0.15 (38)
2000 (10.16)	0.23 (58)

#### 12 x 48

Face Velocity ft/min (m/s)	Pressure Drop in. w.g. (Pa)
1000 (5.08)	0.03 (7)
1500 (7.62)	0.06 (15)
2000 (10.16)	0.11 (27)

#### 36 x 36

Face Velocity ft/min (m/s)	Pressure Drop in. w.g. (Pa)
1000 (5.08)	0.009 (2)
1500 (7.62)	0.02 (5)
2000 (10.16)	0.03 (7)

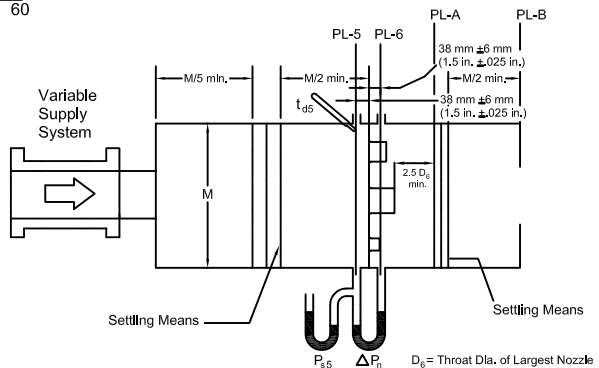

Figure 6.5- Airflow Rate Measurement Setup- Multiple Nozzle Chamber on Fan Outlet

# MODEL NAH-721-1 PERFORMANCE DATA

## Imperial Units (Forward Flow)

Damper Width X Height	1 in. w.g. Class	4 in. w.g. Class	8 in. wg Class	*Torque (per sq. ft.)
12" x 12"	Class I	Class II	Class II	15 lbs/in
24" X 24"	Class I	Class I	Class I	12.59 lbs/in
36" X 36"	Class I	Class I	Class I	15 lbs/in
12" X 48"	Class III	Class III	Class II	12.59 lbs/in
48" X 12"	Class I	Class I	Class I	12.59 lbs/in
60" X 36"	Class II	Class II	Class II	15 lbs/in

Air leakage is based on operation between 50°F to 104°F. All data corrected to represent air density of 0.075 lbs/ft.<sup>3</sup>

\*Torque applied to hold damper in closed position

## Imperial Units (Back Flow)

Damper Width X Height	1 in. w.g. Class	4 in. w.g. Class	8 in. wg Class	*Torque (per sq. ft.)
12" x 12"	Class II	Class III	Class III	15 lbs/in
24" X 24"	Class I	Class I	Class II	12.59 lbs/in
36" X 36"	Class II	Class III	Class III	15 lbs/in
12" X 48"	Class III	Class III	Class III	12.59 lbs/in
48" X 12"	Class II	Class II	Class II	12.59 lbs/in
60" X 36"	Class III	Class III	Class II	15 lbs/in

\*Torque applied to hold damper in closed position

		Leakage, ft <sup>3</sup> /min <sup>2</sup> /ft			
		Required Rating		Extended Ranges (optional)	
Class	Pressure	1"	4"	8"	12"
		I	4	8	11
II	10	20	28	35	
III	40	80	112	140	

All data corrected to represent standard air at a density of 0.075 lbs/ft.

NAH-720 SOUND RATINGS								
Damper Size	Damper Full Open		Damper 75% Open		Damper 50% Open		Damper 25% Open	
	CFM	NC	CFM	NC	CFM	NC	CFM	NC
12 x 12	2000	16	1500	11	1000	11	500	*
	3000	28	2250	21	1500	18	750	*
	4000	36	3000	29	2000	24	1000	*
18 x 18	2250	17	1688	10	1125	21	563	*
	4500	33	3375	26	2250	31	1125	*
	6750	43	5063	37	3375	40	1688	15
24 x 24	4000	11	3000	10	2000	26	1000	*
	8000	33	6000	29	4000	37	2000	21
	12000	43	9000	42	6000	46	3000	31

NC = Noise criteria in Decibels is based on room effect and 10db of room attenuation.  
\* = Less than 10 NC

3

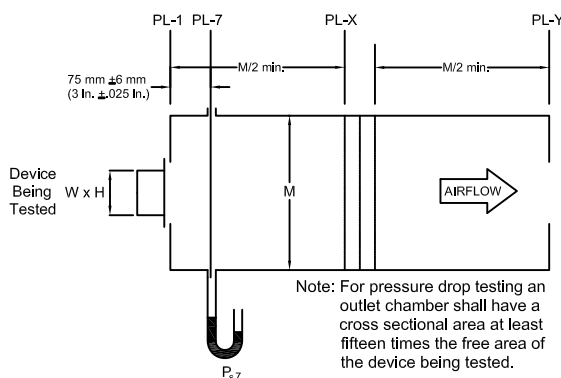

Figure 5.4- Test Device Setup with Outlet Chamber

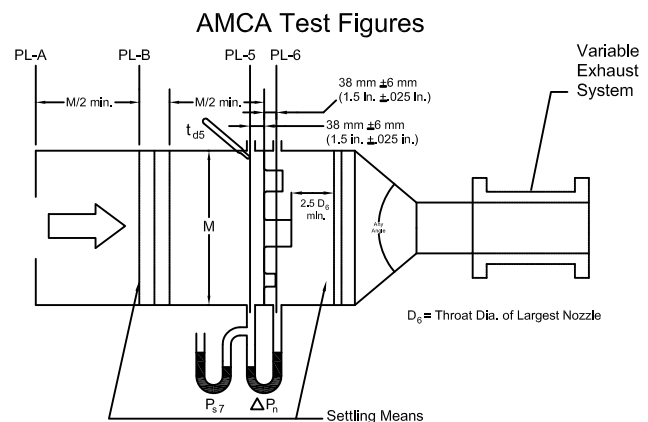

Figure 6.3- Airflow Rate Measurement Setup- Multiple Nozzle Chamber on Fan Inlet

# MODEL NAH-721-1 PERFORMANCE DATA

## Standard International Units (Forward Flow)

Damper Width X Height (mm)	250 Pa Class	1 KPa Class	2 KPa Class	*Torque
305 x 305	Class I	Class II	Class II	2,679 grams/cm
610 X 610	Class I	Class I	Class I	2,248 grams/cm
915 X 915	Class I	Class I	Class I	2,679 grams/cm
305 X 1220	Class III	Class III	Class II	2,248 grams/cm
1220 X 305	Class I	Class I	Class I	2,248 grams/cm
1525 X 915	Class II	Class II	Class II	2,679 grams/cm

Air leakage is based on operation between 10°C to 40°C. All data corrected to represent air density of 1.201 kg/m<sup>3</sup>

\*Torque applied to hold damper in closed position

## Standard International Units (Back Flow)

Damper Width X Height (mm)	250 Pa Class	1 KPa Class	2 KPa Class	*Torque
305 x 305	Class II	Class III	Class III	2,679 grams/cm
610 X 610	Class I	Class I	Class II	2,248 grams/cm
915 X 915	Class II	Class III	Class III	2,679 grams/cm
305 X 1220	Class III	Class III	Class III	2,248 grams/cm
1220 X 305	Class II	Class II	Class II	2,248 grams/cm
1525 X 915	Class III	Class III	Class II	2,679 grams/cm

\*Torque applied to hold damper in closed position

		Leakage, L/s /m <sup>2</sup>			
		Required Rating		Extended Ranges (optional)	
Class	Pressure	0.25 kPa	1.0 kPa	2.0 kPa	3.0 kPa
I		20.3	40.6	55.9	71.1
II		50.8	102	142	178
III		203	406	569	711

## FRAME & BOLT HOLE CONSTRUCTION OPTIONS

Flange (F Dim): Standard - 2"  
Optional - 1-1/2" to 4"

Bolt holes: (Standard construction is no bolt holes)

Web (D Dim): Standard - 8"  
Optional - 8" to 12"

Dim. "M": 7/16" dia. hole  
Dim. "L": 6" Center to Center

**Note:** Customer must be within Min. or Max limits on table below.

Dim.	Min or Max	Standard	Description
<b>J</b>	min. 3/4"		First/Last Space in <u>Head/Sill</u>
<b>N1</b>	min. 1.0"		No. of holes in <u>Head/Sill</u>
<b>K</b>	min. F/2"		First/Last Space in <u>Jamb</u>
<b>N2</b>	min. 1.0"		No. of holes in <u>Jamb</u>
<b>C</b>	.75*D" to 3/4"	F/(2*M)"	Centerline of bolt hole from inside edge of frame
<b>L</b>	2" to 12"	6.0"	Hole Spacing
<b>M</b>	1/4" to 11/16"	7/16"	Mounting hole Diameter

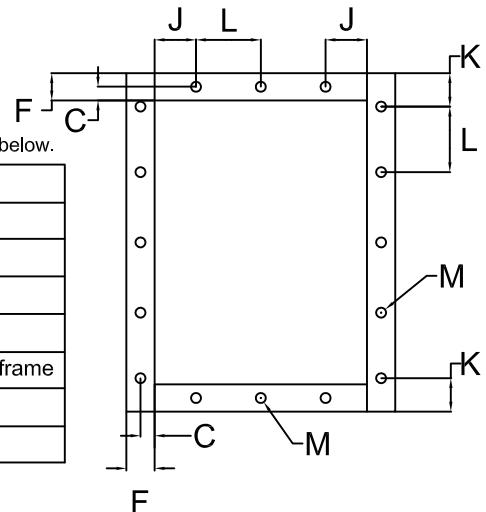



# MODEL NAH-721-1 PERFORMANCE DATA

## PRESSURE DROP

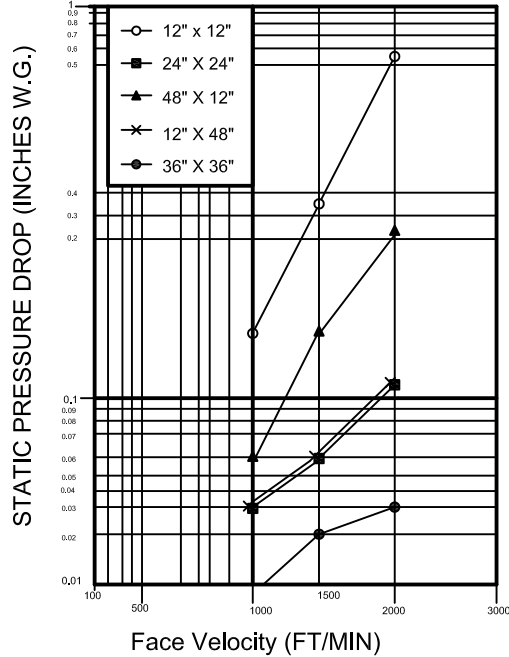

Face Velocity (FT/MIN)  
Based on STANDARD AIR- .075 lb. per cubic foot.  
NAH-720-1 sizes: 12x12, 24x24, 48x12, 12x48, 36x36  
(305x305, 610x610, 1219x305, 305x1219, 914x914)

### NAH-720-1

#### PRESSURE LIMITATIONS

The chart at the right shows conservative pressure limitations based on a maximum blade deflection of w/360.

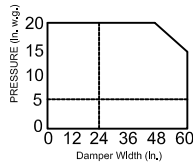

#### TEMPERATURE LIMITATIONS

Blade Seals: EPDM -40° to +250°F  
Silicone Rubber -40° to +450°F  
Jamb Seals: Flexible stainless steel -40° to +400°F

#### VELOCITY LIMITATIONS

The chart at the right shows conservative velocity limitations based on damper size.

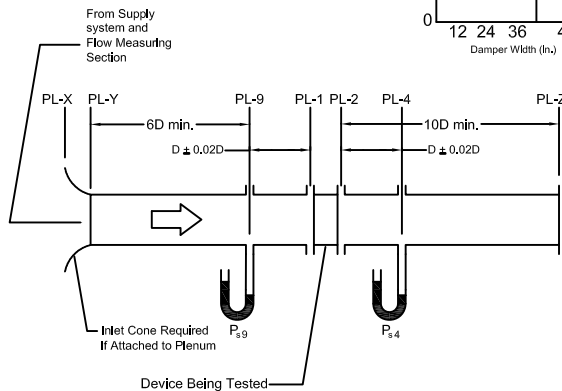
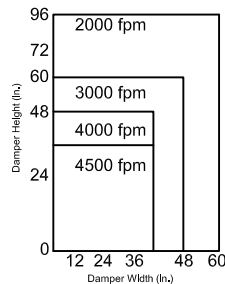

Figure 5.3- Test Device Setup with Inlet and Outlet Ducts

### AMCA Test Figure 5.3

Figure 5.3 illustrates a fully ducted damper. This configuration has low pressure drop because entrance and exit losses are minimized by straight duct runs upstream and downstream of the damper.

#### Pressure Drop Data

This pressure drop data was conducted in accordance with AMCA Standard 500 using Test Figure 5.3. All data has been corrected to represent standard air at a density of .075 lb/cu.ft.

Actual pressure drop found in any HVAC system is a combination of many factors. This pressure drop information along with an analysis of other system influences should be used to estimate actual pressure losses for a damper installed in a given HVAC system.

12 x 12	
Face Velocity ft/min (m/s)	Pressure Drop in. w.g. (Pa)
1000 (5.08)	0.15 (38)
1500 (7.62)	0.33 (83)
2000 (10.16)	0.55 (139)

24 x 24	
Face Velocity ft/min (m/s)	Pressure Drop in. w.g. (Pa)
1000 (5.08)	0.03 (7)
1500 (7.62)	0.06 (15)
2000 (10.16)	0.11 (27)

48 x 12	
Face Velocity ft/min (m/s)	Pressure Drop in. w.g. (Pa)
1000 (5.08)	0.06 (15)
1500 (7.62)	0.15 (38)
2000 (10.16)	0.23 (58)

12 x 48	
Face Velocity ft/min (m/s)	Pressure Drop in. w.g. (Pa)
1000 (5.08)	0.03 (7)
1500 (7.62)	0.06 (15)
2000 (10.16)	0.11 (27)

36 x 36	
Face Velocity ft/min (m/s)	Pressure Drop in. w.g. (Pa)
1000 (5.08)	0.009 (2)
1500 (7.62)	0.02 (5)
2000 (10.16)	0.03 (7)

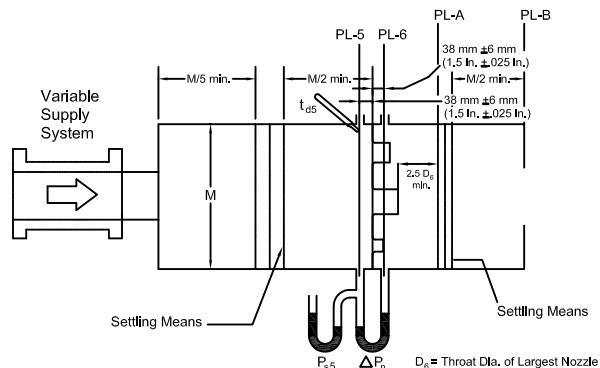

Figure 6.5- Airflow Rate Measurement Setup- Multiple Nozzle Chamber on Fan Outlet

# MODEL NAH-721-2 PERFORMANCE DATA

## Imperial Units (Forward Flow)

Damper Width X Height	1 in. w.g. Class	4 in. w.g. Class	8 in. wg Class	*Torque (per sq. ft.)
12" x 12"	Class I	Class II	Class II	15 lbs/in
24" X 24"	Class I	Class I	Class I	12.59 lbs/in
36" X 36"	Class I	Class I	Class I	15 lbs/in
12" X 48"	Class III	Class III	Class II	12.59 lbs/in
48" X 12"	Class I	Class I	Class I	12.59 lbs/in
60" X 36"	Class II	Class II	Class II	15 lbs/in

Air leakage is based on operation between 50°F to 104°F. All data corrected to represent air density of 0.075 lbs/ft.<sup>3</sup>

\*Torque applied to hold damper in closed position

## Imperial Units (Back Flow)

Damper Width X Height	1 in. w.g. Class	4 in. w.g. Class	8 in. wg Class	*Torque (per sq. ft.)
12" x 12"	Class II	Class III	Class III	15 lbs/in
24" X 24"	Class I	Class I	Class II	12.59 lbs/in
36" X 36"	Class II	Class III	Class III	15 lbs/in
12" X 48"	Class III	Class III	Class III	12.59 lbs/in
48" X 12"	Class II	Class II	Class II	12.59 lbs/in
60" X 36"	Class III	Class III	Class II	15 lbs/in

\*Torque applied to hold damper in closed position

		Leakage, ft <sup>3</sup> /min <sup>2</sup> /ft			
		Required Rating		Extended Ranges (optional)	
Class	Pressure	1"	4"	8"	12"
	I		4	8	11
II		10	20	28	35
III		40	80	112	140

All data corrected to represent standard air at a density of 0.075 lbs/ft.

NAH-720 SOUND RATINGS								
Damper Size	Damper Full Open		Damper 75% Open		Damper 50% Open		Damper 25% Open	
	CFM	NC	CFM	NC	CFM	NC	CFM	NC
12 x 12	2000	16	1500	11	1000	11	500	*
	3000	28	2250	21	1500	18	750	*
	4000	36	3000	29	2000	24	1000	*
18 x 18	2250	17	1688	10	1125	21	563	*
	4500	33	3375	26	2250	31	1125	*
	6750	43	5063	37	3375	40	1688	15
24 x 24	4000	11	3000	10	2000	26	1000	*
	8000	33	6000	29	4000	37	2000	21
	12000	43	9000	42	6000	46	3000	31

NC = Noise criteria In Decibels Is based on room effect and 10db of room attenuation.  
\* = Less than 10 NC

## AMCA Test Figures

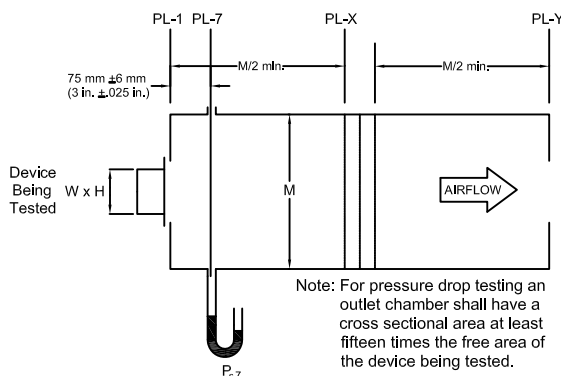

Figure 5.4- Test Device Setup with Outlet Chamber

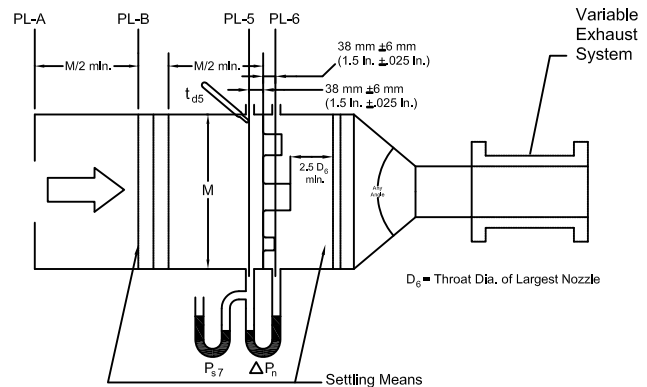

Figure 6.3- Airflow Rate Measurement Setup- Multiple Nozzle Chamber on Fan Inlet

# MODEL NAH-721-2 PERFORMANCE DATA

## Standard International Units (Forward Flow)

Damper Width X Height (mm)	250 Pa Class	1 KPa Class	2 KPa Class	*Torque
305 x 305	Class I	Class II	Class II	2,679 grams/cm
610 X 610	Class I	Class I	Class I	2,248 grams/cm
915 X 915	Class I	Class I	Class I	2,679 grams/cm
305 X 1220	Class III	Class III	Class II	2,248 grams/cm
1220 X 305	Class I	Class I	Class I	2,248 grams/cm
1525 X 915	Class II	Class II	Class II	2,679 grams/cm

Air leakage is based on operation between 10°C to 40°C. All data corrected to represent air density of 1.201 kg/m<sup>3</sup>.

\*Torque applied to hold damper in closed position

## Standard International Units (Back Flow)

Damper Width X Height (mm)	250 Pa Class	1 KPa Class	2 KPa Class	*Torque
305 x 305	Class II	Class III	Class III	2,679 grams/cm
610 X 610	Class I	Class I	Class II	2,248 grams/cm
915 X 915	Class II	Class III	Class III	2,679 grams/cm
305 X 1220	Class III	Class III	Class III	2,248 grams/cm
1220 X 305	Class II	Class II	Class II	2,248 grams/cm
1525 X 915	Class III	Class III	Class II	2,679 grams/cm

\*Torque applied to hold damper in closed position

		Leakage, L/s /m <sup>2</sup>			
		Required Rating		Extended Ranges (optional)	
Class	Pressure	0.25 kPa	1.0 kPa	2.0 kPa	3.0 kPa
I		20.3	40.6	55.9	71.1
II		50.8	102	142	178
III		203	406	569	711

## FRAME CONSTRUCTION OPTIONS

Flange (F Dim): Standard - 2"  
Optional - 1-1/2" to 4"

Bolt holes: (Standard construction is **no** bolt holes)

Web (D Dim): Standard - 8"  
Optional - 8" to 12"

Dim. "M": 7/16" dia. hole  
Dim. "L": 6" Center to Center

**Note:** Customer must be within Min. or Max limits on table below.

Dim.	Min or Max	Standard	Description
<b>J</b>	min. 3/4"		First/Last Space in <b>Head/Sill</b>
<b>N1</b>	min. 1.0"		No. of holes in <b>Head/Sill</b>
<b>K</b>	min. F/2"		First/Last Space in <b>Jamb</b>
<b>N2</b>	min. 1.0"		No. of holes in <b>Jamb</b>
<b>C</b>	.75*D" to 3/4"	F/(2*M)"	Centerline of bolt hole from inside edge of frame
<b>L</b>	2" to 12"	6.0"	Hole Spacing
<b>M</b>	1/4" to 11/16"	7/16"	Mounting hole Diameter

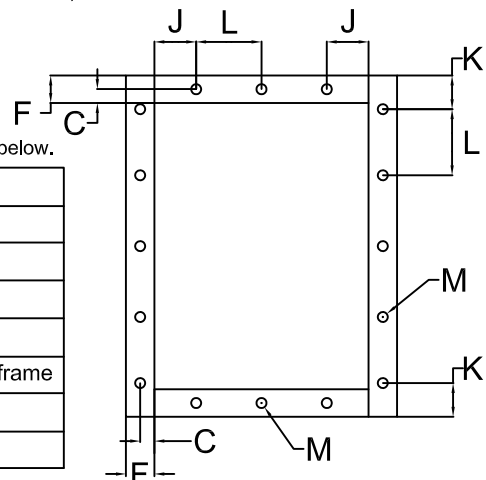

# MODEL NAH-721-2 PERFORMANCE DATA

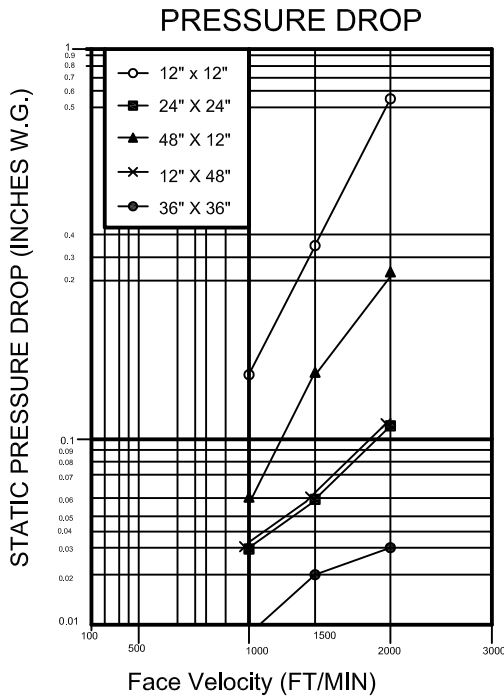

Face Velocity (FT/MIN)

Based on STANDARD AIR- .075 lb. per cubic foot.

NAH-720-2 sizes: 12x12, 24x24, 48x12, 12x48, 36x36  
(305x305, 610x610, 1219x305, 305x1219, 914x914)

#### NAH-720-2

#### PRESSURE LIMITATIONS

The chart at the right shows conservative pressure limitations based on a maximum blade deflection of  $w/360$ .

#### TEMPERATURE LIMITATIONS

Blade Seals: EPDM  $-40^{\circ}$  to  $+250^{\circ}$ F  
Silicone Rubber  $-40^{\circ}$  to  $+450^{\circ}$ F  
Jamb Seals: Flexible stainless steel  $-40^{\circ}$  to  $+400^{\circ}$ F

#### VELOCITY LIMITATIONS

The chart at the right shows conservative velocity limitations based on damper size.

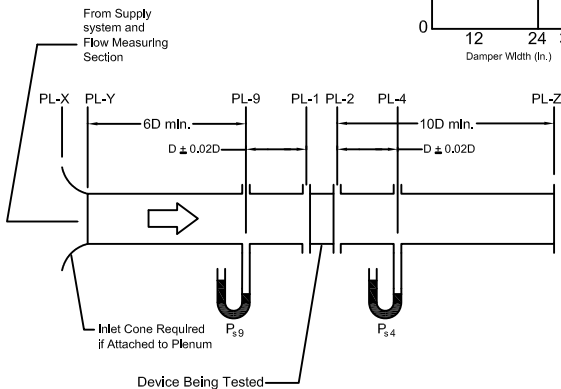
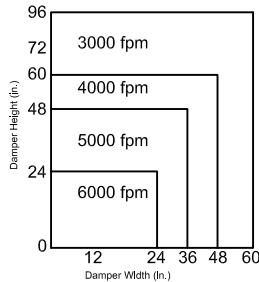
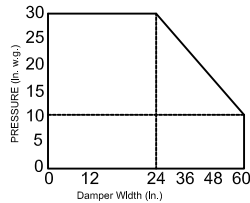

Figure 5.3- Test Device Setup with Inlet and Outlet Ducts

#### AMCA Test Figure 5.3

Figure 5.3 illustrates a fully ducted damper. This configuration has low pressure drop because entrance and exit losses are minimized by straight duct runs upstream and downstream of the damper.

#### Pressure Drop Data

This pressure drop data was conducted in accordance with AMCA Standard 500 using Test Figure 5.3. All data has been corrected to represent standard air at a density of .075 lb/cu.ft.

Actual pressure drop found in any HVAC system is a combination of many factors. This pressure drop information along with an analysis of other system influences should be used to estimate actual pressure losses for a damper installed in a given HVAC system.

#### 12 x 12

Face Velocity ft/min (m/s)	Pressure Drop in. w.g. (Pa)
1000 (5.08)	0.15 (38)
1500 (7.62)	0.33 (83)
2000 (10.16)	0.55 (139)

#### 24 x 24

Face Velocity ft/min (m/s)	Pressure Drop in. w.g. (Pa)
1000 (5.08)	0.03 (7)
1500 (7.62)	0.06 (15)
2000 (10.16)	0.11 (27)

#### 48 x 12

Face Velocity ft/min (m/s)	Pressure Drop in. w.g. (Pa)
1000 (5.08)	0.06 (15)
1500 (7.62)	0.15 (38)
2000 (10.16)	0.23 (58)

#### 12 x 48

Face Velocity ft/min (m/s)	Pressure Drop in. w.g. (Pa)
1000 (5.08)	0.03 (7)
1500 (7.62)	0.06 (15)
2000 (10.16)	0.11 (27)

#### 36 x 36

Face Velocity ft/min (m/s)	Pressure Drop in. w.g. (Pa)
1000 (5.08)	0.009 (2)
1500 (7.62)	0.02 (5)
2000 (10.16)	0.03 (7)

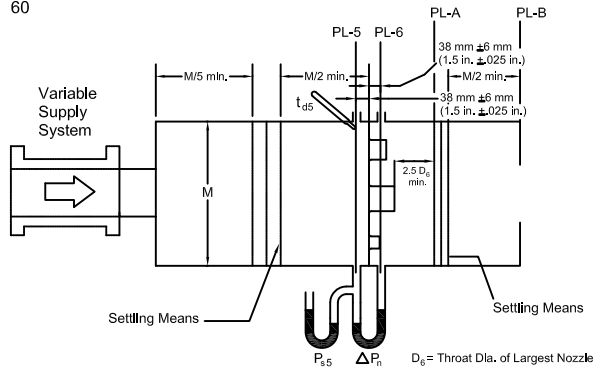

Figure 6.5- Airflow Rate Measurement Setup- Multiple Nozzle Chamber on Fan Outlet

# MODEL NAH-720-3 PERFORMANCE DATA

## Imperial Units (Forward Flow)

Damper Width X Height	1 in. w.g. Class	4 in. w.g. Class	8 in. wg Class	*Torque (per sq. ft.)
12" x 12"	Class I	Class II	Class II	15 lbs/in
24" X 24"	Class I	Class I	Class I	12.59 lbs/in
36" X 36"	Class I	Class I	Class I	15 lbs/in
12" X 48"	Class III	Class III	Class II	12.59 lbs/in
48" X 12"	Class I	Class I	Class I	12.59 lbs/in
60" X 36"	Class II	Class II	Class II	15 lbs/in

Air leakage is based on operation between 50°F to 104°F. All data corrected to represent air density of 0.075 lbs/ft.<sup>3</sup>

\*Torque applied to hold damper in closed position

## Imperial Units (Back Flow)

Damper Width X Height	1 in. w.g. Class	4 in. w.g. Class	8 in. wg Class	*Torque (per sq. ft.)
12" x 12"	Class II	Class III	Class III	15 lbs/in
24" X 24"	Class I	Class I	Class II	12.59 lbs/in
36" X 36"	Class II	Class III	Class III	15 lbs/in
12" X 48"	Class III	Class III	Class III	12.59 lbs/in
48" X 12"	Class II	Class II	Class II	12.59 lbs/in
60" X 36"	Class III	Class III	Class II	15 lbs/in

\*Torque applied to hold damper in closed position

		Leakage, ft <sup>3</sup> /min <sup>2</sup> /ft			
		Required Rating		Extended Ranges (optional)	
Class	Pressure	1"	4"	8"	12"
	I		4	8	11
II		10	20	28	35
III		40	80	112	140

All data corrected to represent standard air at a density of 0.075 lbs/ft.

NAH-720 SOUND RATINGS								
Damper Size	Damper Full Open		Damper 75% Open		Damper 50% Open		Damper 25% Open	
	CFM	NC	CFM	NC	CFM	NC	CFM	NC
12 x 12	2000	16	1500	11	1000	11	500	*
	3000	28	2250	21	1500	18	750	*
	4000	36	3000	29	2000	24	1000	*
18 x 18	2250	17	1688	10	1125	21	563	*
	4500	33	3375	26	2250	31	1125	*
	6750	43	5063	37	3375	40	1688	15
24 x 24	4000	11	3000	10	2000	26	1000	*
	8000	33	6000	29	4000	37	2000	21
	12000	43	9000	42	6000	46	3000	31

NC = Noise criteria In Decibels Is based on room effect and 10db of room attenuation.  
\* = Less than 10 NC

## AMCA Test Figures

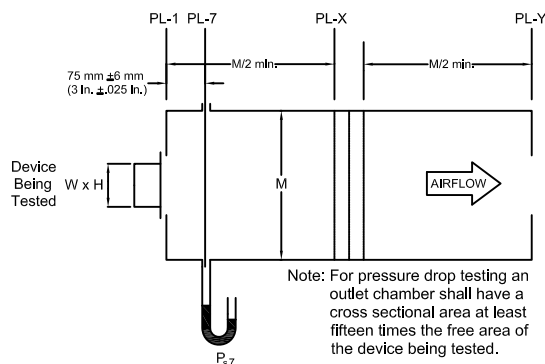

Figure 5.4- Test Device Setup with Outlet Chamber

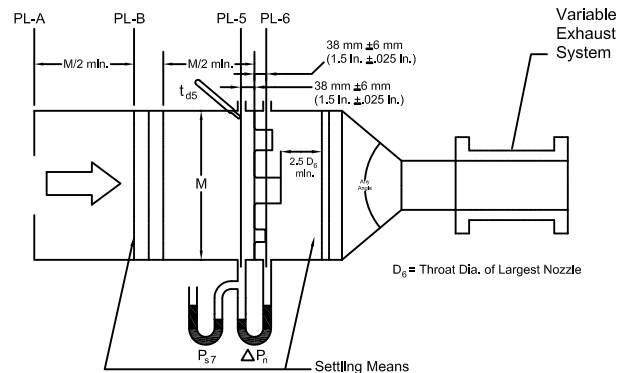

Figure 6.3- Airflow Rate Measurement Setup- Multiple Nozzle Chamber on Fan Inlet

# MODEL NAH-720-3 PERFORMANCE DATA

## Standard International Units (Forward Flow)

Damper Width X Height (mm)	250 Pa Class	1 KPa Class	2 KPa Class	*Torque
305 x 305	Class I	Class II	Class II	2,679 grams/cm
610 X 610	Class I	Class I	Class I	2,248 grams/cm
915 X 915	Class I	Class I	Class I	2,679 grams/cm
305 X 1220	Class III	Class III	Class II	2,248 grams/cm
1220 X 305	Class I	Class I	Class I	2,248 grams/cm
1525 X 915	Class II	Class II	Class II	2,679 grams/cm

Air leakage is based on operation between 10°C to 40°C. All data corrected to represent air density of 1.201 kg/m<sup>3</sup>.

\*Torque applied to hold damper in closed position

## Standard International Units (Back Flow)

Damper Width X Height (mm)	250 Pa Class	1 KPa Class	2 KPa Class	*Torque
305 x 305	Class II	Class III	Class III	2,679 grams/cm
610 X 610	Class I	Class I	Class II	2,248 grams/cm
915 X 915	Class II	Class III	Class III	2,679 grams/cm
305 X 1220	Class III	Class III	Class III	2,248 grams/cm
1220 X 305	Class II	Class II	Class II	2,248 grams/cm
1525 X 915	Class III	Class III	Class II	2,679 grams/cm

\*Torque applied to hold damper in closed position

		Leakage, L/s /m <sup>2</sup>			
		Required Rating		Extended Ranges (optional)	
Class	Pressure	0.25 kPa	1.0 kPa	2.0 kPa	3.0 kPa
I		20.3	40.6	55.9	71.1
II		50.8	102	142	178
III		203	406	569	711

## FRAME CONSTRUCTION OPTIONS

Flange (F Dim): Standard- 2"      Bolt holes: (Standard construction is **no** bolt holes)  
 Optional - 1-1/2" to 4"

Web (D Dim): Standard - 8"      Dim. "M": 7/16" dia. hole  
 Optional - 8" to 12"      Dim. "L": 6" Center to Center

Note: Customer must be within Min. or Max limits on table below.

Dim.	Min or Max	Standard	Description
<b>J</b>	min. 3/4"		First/Last Space in <b>Head/Sill</b>
<b>N1</b>	min. 1.0"		No. of holes in <b>Head/Sill</b>
<b>K</b>	min. F/2"		First/Last Space in <b>Jamb</b>
<b>N2</b>	min. 1.0"		No. of holes in <b>Jamb</b>
<b>C</b>	.75*D" to 3/4"	F/(2*M)"	Centerline of bolt hole from inside edge of frame
<b>L</b>	2" to 12"	6.0"	Hole Spacing
<b>M</b>	1/4" to 11/16"	7/16"	Mounting hole Diameter

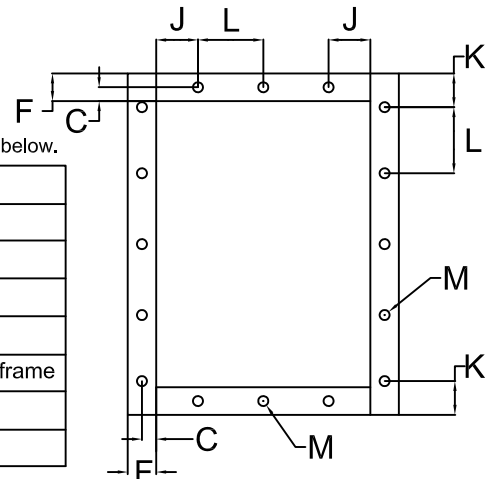

# MODEL NAH-720-3 PERFORMANCE DATA

## PRESSURE DROP

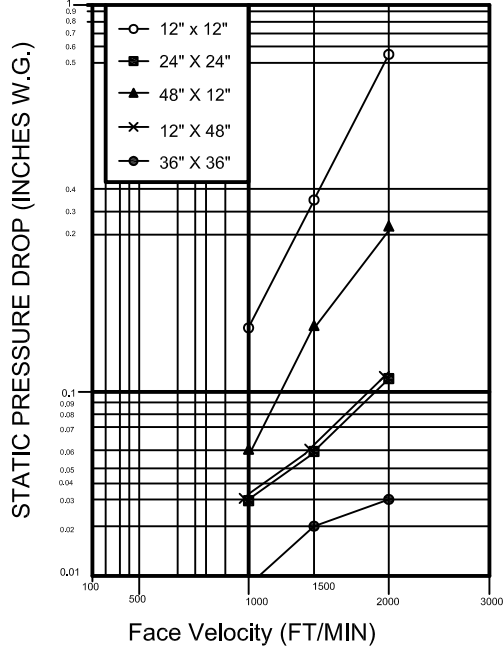

Face Velocity (FT/MIN)

Based on STANDARD AIR- .075 lb. per cubic foot.

NAH-720-3 sizes: 12x12, 24x24, 48x12, 12x48, 36x36  
(305x305, 610x610, 1219x305, 305x1219, 914x914)

### NAH-720-3

#### PRESSURE LIMITATIONS

The chart at the right shows conservative pressure limitations based on a maximum blade deflection of w/360.

#### TEMPERATURE LIMITATIONS

Blade Seals: EPDM -40° to +250°F  
Silicone Rubber -40° to +450°F  
Jamb Seals: Flexible stainless steel -40° to +400°F

#### VELOCITY LIMITATIONS

The chart at the right shows conservative velocity limitations based on damper size.

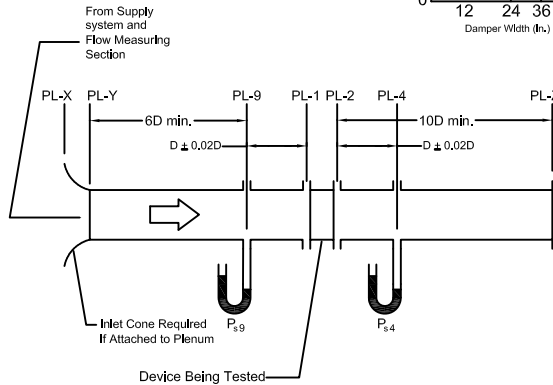
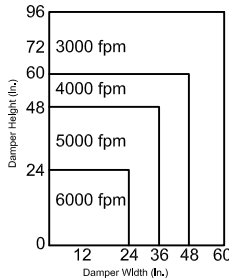
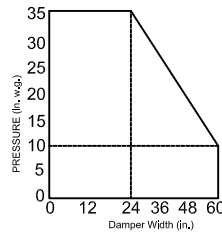

Figure 5.3- Test Device Setup with Inlet and Outlet Ducts

### AMCA Test Figure 5.3

Figure 5.3 illustrates a fully ducted damper. This configuration has low pressure drop because entrance and exit losses are minimized by straight duct runs upstream and downstream of the damper.

#### Pressure Drop Data

This pressure drop data was conducted in accordance with AMCA Standard 500 using Test Figure 5.3. All data has been corrected to represent standard air at a density of .075 lb/cu.ft.

Actual pressure drop found in any HVAC system is a combination of many factors. This pressure drop information along with an analysis of other system influences should be used to estimate actual pressure losses for a damper installed in a given HVAC system.

12 x 12	
Face Velocity ft/min (m/s)	Pressure Drop in. w.g. (Pa)
1000 (5.08)	0.15 (38)
1500 (7.62)	0.33 (83)
2000 (10.16)	0.55 (139)

24 x 24	
Face Velocity ft/min (m/s)	Pressure Drop in. w.g. (Pa)
1000 (5.08)	0.03 (7)
1500 (7.62)	0.06 (15)
2000 (10.16)	0.11 (27)

48 x 12	
Face Velocity ft/min (m/s)	Pressure Drop in. w.g. (Pa)
1000 (5.08)	0.06 (15)
1500 (7.62)	0.15 (38)
2000 (10.16)	0.23 (58)

12 x 48	
Face Velocity ft/min (m/s)	Pressure Drop in. w.g. (Pa)
1000 (5.08)	0.03 (7)
1500 (7.62)	0.06 (15)
2000 (10.16)	0.11 (27)

36 x 36	
Face Velocity ft/min (m/s)	Pressure Drop in. w.g. (Pa)
1000 (5.08)	0.009 (2)
1500 (7.62)	0.02 (5)
2000 (10.16)	0.03 (7)

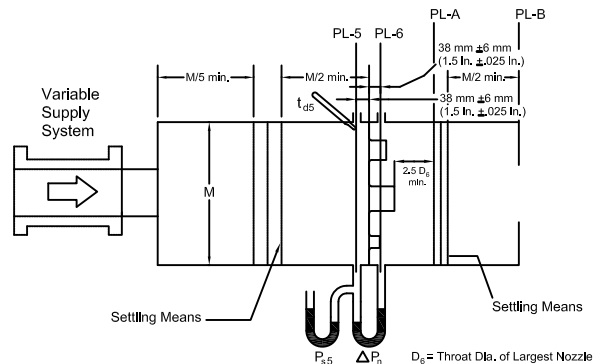

Figure 6.5- Airflow Rate Measurement Setup- Multiple Nozzle Chamber on Fan Outlet

# MODEL NAH-721-3 PERFORMANCE DATA

## Imperial Units (Forward Flow)

Damper Width X Height	1 in. w.g. Class	4 in. w.g. Class	8 in. wg Class	*Torque (per sq. ft.)
12" x 12"	Class I	Class II	Class II	15 lbs/in
24" X 24"	Class I	Class I	Class I	12.59 lbs/in
36" X 36"	Class I	Class I	Class I	15 lbs/in
12" X 48"	Class III	Class III	Class II	12.59 lbs/in
48" X 12"	Class I	Class I	Class I	12.59 lbs/in
60" X 36"	Class II	Class II	Class II	15 lbs/in

Air leakage is based on operation between 50°F to 104°F. All data corrected to represent air density of 0.075 lbs/ft.<sup>3</sup>

\*Torque applied to hold damper in closed position

## Imperial Units (Back Flow)

Damper Width X Height	1 in. w.g. Class	4 in. w.g. Class	8 in. wg Class	*Torque (per sq. ft.)
12" x 12"	Class II	Class III	Class III	15 lbs/in
24" X 24"	Class I	Class I	Class II	12.59 lbs/in
36" X 36"	Class II	Class III	Class III	15 lbs/in
12" X 48"	Class III	Class III	Class III	12.59 lbs/in
48" X 12"	Class II	Class II	Class II	12.59 lbs/in
60" X 36"	Class III	Class III	Class II	15 lbs/in

\*Torque applied to hold damper in closed position

		Leakage, ft <sup>3</sup> /min <sup>2</sup> /ft			
		Required Rating		Extended Ranges (optional)	
Class	Pressure	1"	4"	8"	12"
	I		4	8	11
II		10	20	28	35
III		40	80	112	140

All data corrected to represent standard air at a density of 0.075 lbs/ft.

NAH-720 SOUND RATINGS								
Damper Size	Damper Full Open		Damper 75% Open		Damper 50% Open		Damper 25% Open	
	CFM	NC	CFM	NC	CFM	NC	CFM	NC
12 x 12	2000	16	1500	11	1000	11	500	*
	3000	28	2250	21	1500	18	750	*
	4000	36	3000	29	2000	24	1000	*
18 x 18	2250	17	1688	10	1125	21	563	*
	4500	33	3375	26	2250	31	1125	*
	6750	43	5063	37	3375	40	1688	15
24 x 24	4000	11	3000	10	2000	26	1000	*
	8000	33	6000	29	4000	37	2000	21
	12000	43	9000	42	6000	46	3000	31

NC = Noise criteria In Decibels Is based on room effect and 10db of room attenuation.  
\* = Less than 10 NC

## AMCA Test Figures

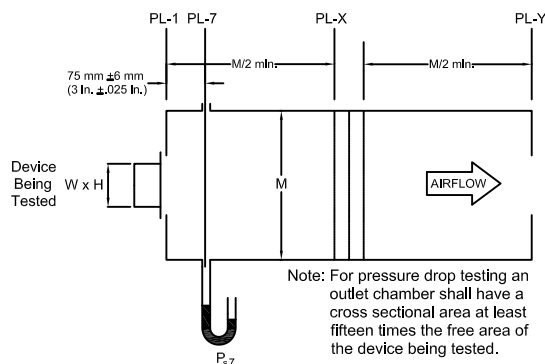

Figure 5.4- Test Device Setup with Outlet Chamber

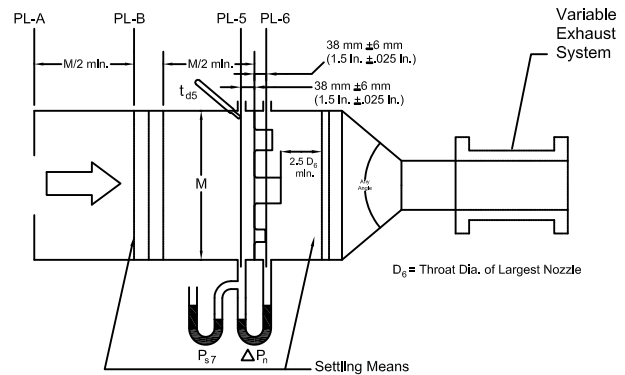

Figure 6.3- Airflow Rate Measurement Setup- Multiple Nozzle Chamber on Fan Inlet



## Standard International Units (Forward Flow)

Damper Width X Height (mm)	250 Pa Class	1 KPa Class	2 KPa Class	*Torque
305 x 305	Class I	Class II	Class II	2,679 grams/cm
610 X 610	Class I	Class I	Class I	2,248 grams/cm
915 X 915	Class I	Class I	Class I	2,679 grams/cm
305 X 1220	Class III	Class III	Class II	2,248 grams/cm
1220 X 305	Class I	Class I	Class I	2,248 grams/cm
1525 X 915	Class II	Class II	Class II	2,679 grams/cm

Air leakage is based on operation between 10°C to 40°C. All data corrected to represent air density of 1.201 kg/m<sup>3</sup>.

\*Torque applied to hold damper in closed position

## Standard International Units (Back Flow)

Damper Width X Height (mm)	250 Pa Class	1 KPa Class	2 KPa Class	*Torque
305 x 305	Class II	Class III	Class III	2,679 grams/cm
610 X 610	Class I	Class I	Class II	2,248 grams/cm
915 X 915	Class II	Class III	Class III	2,679 grams/cm
305 X 1220	Class III	Class III	Class III	2,248 grams/cm
1220 X 305	Class II	Class II	Class II	2,248 grams/cm
1525 X 915	Class III	Class III	Class II	2,679 grams/cm

\*Torque applied to hold damper in closed position

		Leakage, L/s /m <sup>2</sup>			
		Required Rating		Extended Ranges (optional)	
Class	Pressure	0.25 kPa	1.0 kPa	2.0 kPa	3.0 kPa
I		20.3	40.6	55.9	71.1
II		50.8	102	142	178
III		203	406	569	711

## FRAME CONSTRUCTION OPTIONS

Flange (F Dim): Standard- 2" Bolt holes: (Standard construction is **no** bolt holes)  
 Optional - 1-1/2" to 4"

Web (D Dim): Standard - 8" Dim. "M": 7/16" dia. hole  
 Optional - 8" to 12" Dim. "L": 6" Center to Center

Note: Customer must be within Min. or Max limits on table below.

Dim.	Min or Max	Standard	Description
<b>J</b>	min. 3/4"		First/Last Space in <b>Head/Sill</b>
<b>N1</b>	min. 1.0"		No. of holes in <b>Head/Sill</b>
<b>K</b>	min. F/2"		First/Last Space in <b>Jamb</b>
<b>N2</b>	min. 1.0"		No. of holes in <b>Jamb</b>
<b>C</b>	.75*D" to 3/4"	F/(2*M)"	Centerline of bolt hole from inside edge of frame
<b>L</b>	2" to 12"	6.0"	Hole Spacing
<b>M</b>	1/4" to 11/16"	7/16"	Mounting hole Diameter

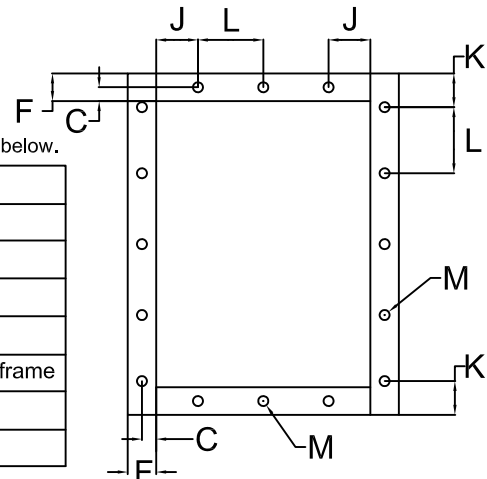

## PRESSURE DROP

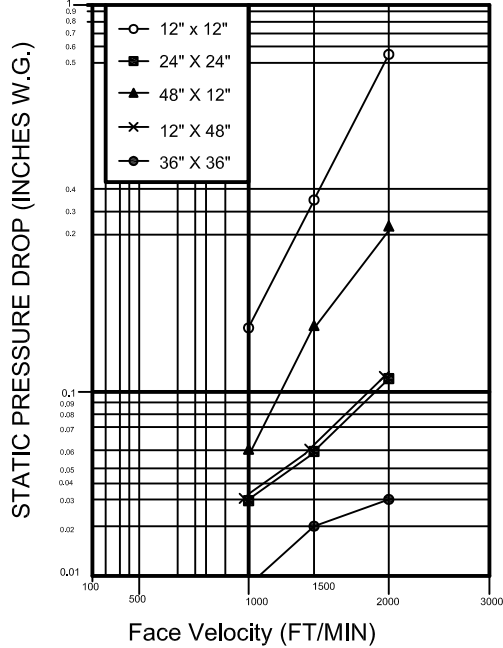

Face Velocity (FT/MIN)

Based on STANDARD AIR- .075 lb. per cubic foot.

NAH-720-3 sizes: 12x12, 24x24, 48x12, 12x48, 36x36  
(305x305, 610x610, 1219x305, 305x1219, 914x914)

### NAH-720-3

#### PRESSURE LIMITATIONS

The chart at the right shows conservative pressure limitations based on a maximum blade deflection of w/360.

#### TEMPERATURE LIMITATIONS

Blade Seals: EPDM -40° to +250°F  
Silicone Rubber -40° to +450°F  
Jamb Seals: Flexible stainless steel -40° to +400°F

#### VELOCITY LIMITATIONS

The chart at the right shows conservative velocity limitations based on damper size.

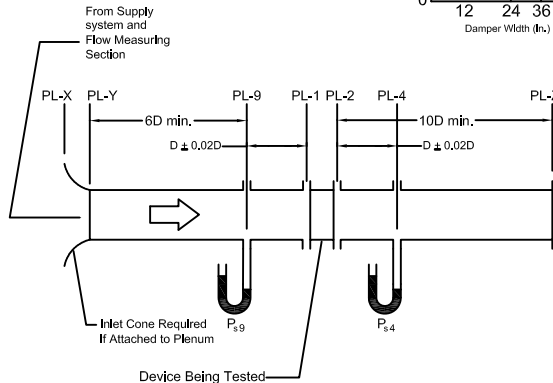
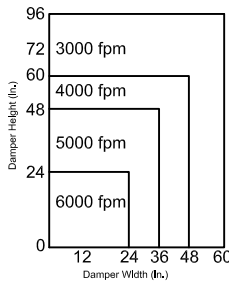
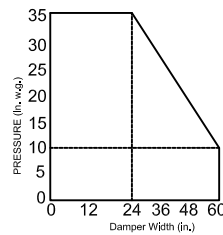

Figure 5.3- Test Device Setup with Inlet and Outlet Ducts

### AMCA Test Figure 5.3

Figure 5.3 illustrates a fully ducted damper. This configuration has low pressure drop because entrance and exit losses are minimized by straight duct runs upstream and downstream of the damper.

#### Pressure Drop Data

This pressure drop data was conducted in accordance with AMCA Standard 500 using Test Figure 5.3. All data has been corrected to represent standard air at a density of .075 lb/cu.ft.

Actual pressure drop found in any HVAC system is a combination of many factors. This pressure drop information along with an analysis of other system influences should be used to estimate actual pressure losses for a damper installed in a given HVAC system.

12 x 12	
Face Velocity ft/min (m/s)	Pressure Drop in. w.g. (Pa)
1000 (5.08)	0.15 (38)
1500 (7.62)	0.33 (83)
2000 (10.16)	0.55 (139)

24 x 24	
Face Velocity ft/min (m/s)	Pressure Drop in. w.g. (Pa)
1000 (5.08)	0.03 (7)
1500 (7.62)	0.06 (15)
2000 (10.16)	0.11 (27)

48 x 12	
Face Velocity ft/min (m/s)	Pressure Drop in. w.g. (Pa)
1000 (5.08)	0.06 (15)
1500 (7.62)	0.15 (38)
2000 (10.16)	0.23 (58)

12 x 48	
Face Velocity ft/min (m/s)	Pressure Drop in. w.g. (Pa)
1000 (5.08)	0.03 (7)
1500 (7.62)	0.06 (15)
2000 (10.16)	0.11 (27)

36 x 36	
Face Velocity ft/min (m/s)	Pressure Drop in. w.g. (Pa)
1000 (5.08)	0.009 (2)
1500 (7.62)	0.02 (5)
2000 (10.16)	0.03 (7)

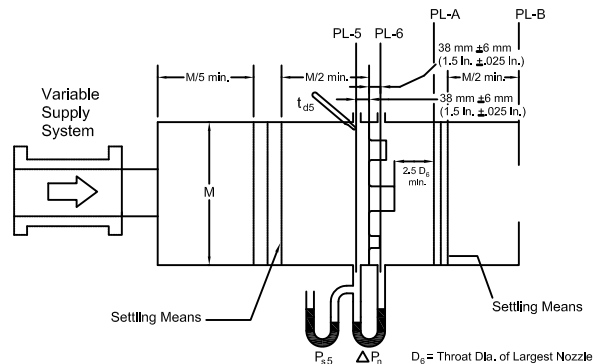

Figure 6.5- Airflow Rate Measurement Setup- Multiple Nozzle Chamber on Fan Outlet

# MODEL NAH-720-4 PERFORMANCE DATA

## Imperial Units (Forward Flow)

Damper Width X Height	1 in. w.g. Class	4 in. w.g. Class	8 in. wg Class	*Torque (per sq. ft.)
12" x 12"	Class I	Class I	Class I	18 lbs-in
24" X 24"	Class I	Class I	Class I	15 lbs-in
36" X 36"	Class I	Class I	Class I	18 lbs-in
12" X 48"	Class I	Class I	Class I	15 lbs-in
48" X 12"	Class I	Class I	Class I	15 lbs-in
60" X 36"	Class I	Class I	Class I	18 lbs-in

\*Torque applied to hold damper in closed position

Air leakage is based on operation between 50°F to 104°F. All data corrected to represent air density of 0.075 lbs/ft.<sup>3</sup>

## Imperial Units (Back Flow)

Damper Width X Height	1 in. w.g. Class	4 in. w.g. Class	8 in. wg Class	*Torque (per sq. ft.)
12" x 12"	Class I	Class I	Class I	18 lbs-in
24" X 24"	Class I	Class I	Class I	15 lbs-in
36" X 36"	Class I	Class I	Class I	18 lbs-in
12" X 48"	Class II	Class II	Class II	15 lbs-in
48" X 12"	Class I	Class I	Class I	15 lbs-in
60" X 36"	Class I	Class II	Class I	18 lbs-in

\*Torque applied to hold damper in closed position

		Leakage, ft <sup>3</sup> /min <sup>2</sup> /ft			
		Required Rating		Extended Ranges (optional)	
Class	Pressure	1"	4"	8"	12"
	I		4	8	11
II		10	20	28	35
III		40	80	112	140

All data corrected to represent standard air at a density of 0.075 lbs/ft.

NAH-720 SOUND RATINGS								
Damper Size	Damper Full Open		Damper 75% Open		Damper 50% Open		Damper 25% Open	
	CFM	NC	CFM	NC	CFM	NC	CFM	NC
12 x 12	2000	16	1500	11	1000	11	500	*
	3000	28	2250	21	1500	18	750	*
	4000	36	3000	29	2000	24	1000	*
18 x 18	2250	17	1688	10	1125	21	563	*
	4500	33	3375	26	2250	31	1125	*
	6750	43	5063	37	3375	40	1688	15
24 x 24	4000	11	3000	10	2000	26	1000	*
	8000	33	6000	29	4000	37	2000	21
	12000	43	9000	42	6000	46	3000	31

NC = Noise criteria in Decibels is based on room effect and 10db of room attenuation.  
\* = Less than 10 NC

## AMCA Test Figures

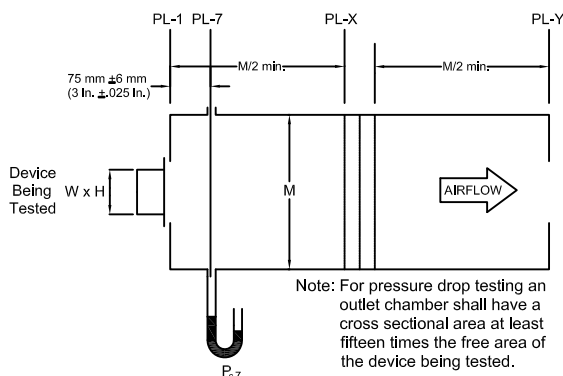

Figure 5.4- Test Device Setup with Outlet Chamber

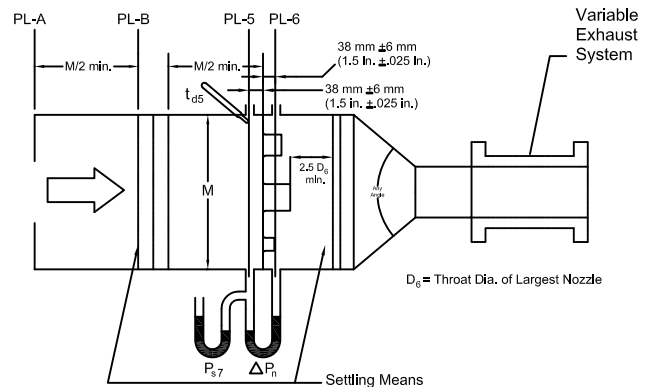

Figure 6.3- Airflow Rate Measurement Setup- Multiple Nozzle Chamber on Fan Inlet

# MODEL NAH-720-4 PERFORMANCE DATA

## Standard International Units (Forward Flow)

Damper Width X Height (mm)	250 Pa Class	1 KPa Class	2 KPa Class	*Torque
305 x 305	Class I	Class I	Class I	3,214 grams-cm
610 X 610	Class I	Class I	Class I	2,679 grams-cm
915 X 915	Class I	Class I	Class I	3,214 grams-cm
305 X 1220	Class I	Class I	Class I	2,679 grams-cm
1220 X 305	Class I	Class I	Class I	2,679 grams-cm
1525 X 915	Class I	Class I	Class I	3,214 grams-cm

Air leakage is based on operation between 10°C to 40°C. All data corrected to represent air density of 1.201 kg/m<sup>3</sup>.

\*Torque applied to hold damper in closed position

## Standard International Units (Back Flow)

Damper Width X Height (mm)	250 Pa Class	1 KPa Class	2 KPa Class	*Torque
305 x 305	Class I	Class I	Class I	3,214 grams-cm
610 X 610	Class I	Class I	Class I	2,679 grams-cm
915 X 915	Class I	Class I	Class I	3,214 grams-cm
305 X 1220	Class II	Class II	Class II	2,679 grams-cm
1220 X 305	Class I	Class I	Class I	2,679 grams-cm
1525 X 915	Class I	Class II	Class I	3,214 grams-cm

\*Torque applied to hold damper in closed position

		Leakage, L/s /m <sup>2</sup>			
		Required Rating		Extended Ranges (optional)	
Class	Pressure	0.25 kPa	1.0 kPa	2.0 kPa	3.0 kPa
		I		20.3	40.6
II		50.8	102	142	178
III		203	406	569	711

## FRAME CONSTRUCTION OPTIONS

Flange (F Dim): Standard- 2"

Optional - 1-1/2" to 4"

Bolt holes: (Standard construction is **no** bolt holes)

Dim. "M": 7/16" dia. hole

Dim. "L": 6" Center to Center

Web (D Dim): Standard - 8"

Optional - 8" to 12"

**Note:** Customer must be within Min. or Max limits on table below.

Dim.	Min or Max	Standard	Description
<b>J</b>	min. 3/4"		First/Last Space in <u>Head/Sill</u>
<b>N1</b>	min. 1.0"		No. of holes in <u>Head/Sill</u>
<b>K</b>	min. F/2"		First/Last Space in <u>Jamb</u>
<b>N2</b>	min. 1.0"		No. of holes in <u>Jamb</u>
<b>C</b>	.75*D" to 3/4"	F/(2*M)"	Centerline of bolt hole from inside edge of frame
<b>L</b>	2" to 12"	6.0"	Hole Spacing
<b>M</b>	1/4" to 11/16"	7/16"	Mounting hole Diameter

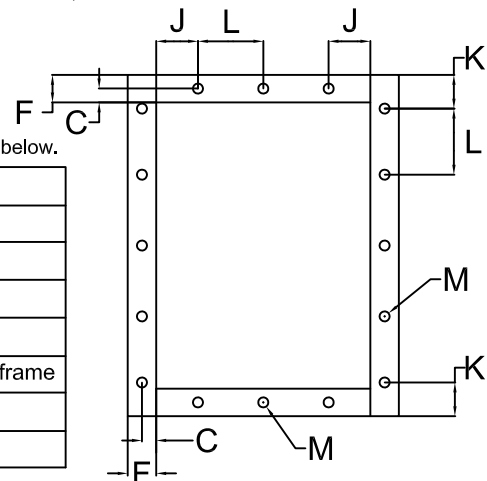

# MODEL NAH-720-4 PERFORMANCE DATA

## PRESSURE DROP

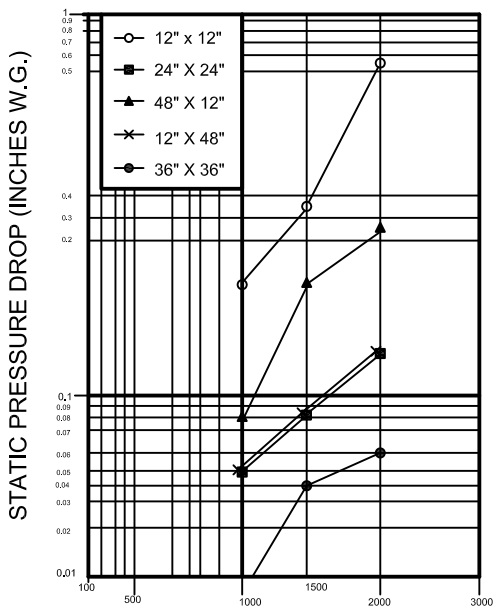

### Face Velocity (FT/MIN)

Based on STANDARD AIR- .075 lb. per cubic foot.

NAH-720-4 sizes: 12x12, 24x24, 48x12, 12x48, 36x36  
(305x305, 610x610, 1219x305, 305x1219, 914x914)

### NAH-720-4

#### PRESSURE LIMITATIONS

The chart at the right shows conservative pressure limitations based on a maximum blade deflection of  $w/360$ .

#### TEMPERATURE LIMITATIONS

Blade Seals: EPDM  $-40^{\circ}$  to  $+250^{\circ}$ F  
Silicone Rubber  $-40^{\circ}$  to  $+450^{\circ}$ F  
Jamb Seals: Flexible stainless steel  $-40^{\circ}$  to  $+400^{\circ}$ F

#### VELOCITY LIMITATIONS

The chart at the right shows conservative velocity limitations based on damper size.

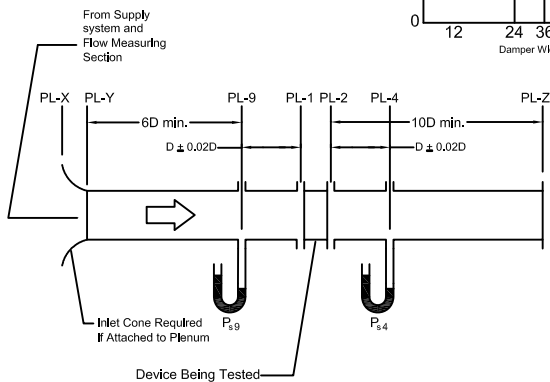
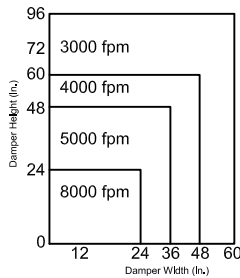
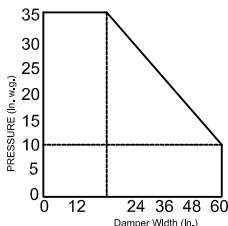

Figure 5.3- Test Device Setup with Inlet and Outlet Ducts

### AMCA Test Figure 5.3

Figure 5.3 illustrates a fully ducted damper. This configuration has low pressure drop because entrance and exit losses are minimized by straight duct runs upstream and downstream of the damper.

### Pressure Drop Data

This pressure drop data was conducted in accordance with AMCA Standard 500 using Test Figure 5.3. All data has been corrected to represent standard air at a density of .075 lb/cu.ft.

Actual pressure drop found in any HVAC system is a combination of many factors. This pressure drop information along with an analysis of other system influences should be used to estimate actual pressure losses for a damper installed in a given HVAC system.

#### 12 x 12

Face Velocity ft/min (m/s)	Pressure Drop in. w.g. (Pa)
1000 (5.08)	0.18 (45)
1500 (7.62)	0.35 (88)
2000 (10.16)	0.57 (144)

#### 24 x 24

Face Velocity ft/min (m/s)	Pressure Drop in. w.g. (Pa)
1000 (5.08)	0.05 (12)
1500 (7.62)	0.08 (20)
2000 (10.16)	0.13 (33)

#### 48 x 12

Face Velocity ft/min (m/s)	Pressure Drop in. w.g. (Pa)
1000 (5.08)	0.08 (20)
1500 (7.62)	0.18 (45)
2000 (10.16)	0.26 (66)

#### 12 x 48

Face Velocity ft/min (m/s)	Pressure Drop in. w.g. (Pa)
1000 (5.08)	0.05 (12)
1500 (7.62)	0.08 (20)
2000 (10.16)	0.13 (33)

#### 36 x 36

Face Velocity ft/min (m/s)	Pressure Drop in. w.g. (Pa)
1000 (5.08)	0.011 (3)
1500 (7.62)	0.04 (10)
2000 (10.16)	0.06 (15)

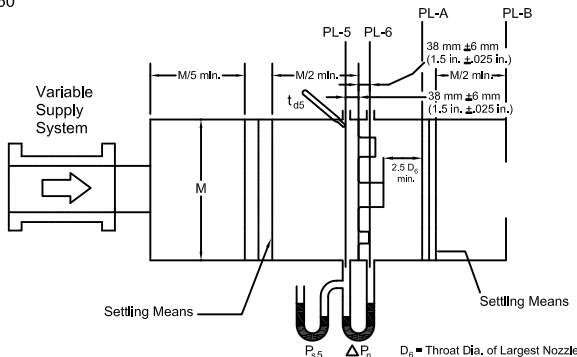

Figure 6.5- Airflow Rate Measurement Setup- Multiple Nozzle Chamber on Fan Outlet

# MODEL NAH-721-4 PERFORMANCE DATA

## Imperial Units (Forward Flow)

Damper Width X Height	1 in. w.g. Class	4 in. w.g. Class	8 in. wg Class	*Torque (per sq. ft.)
12" x 12"	Class I	Class I	Class I	18 lbs-in
24" X 24"	Class I	Class I	Class I	15 lbs-in
36" X 36"	Class I	Class I	Class I	18 lbs-in
12" X 48"	Class I	Class I	Class I	15 lbs-in
48" X 12"	Class I	Class I	Class I	15 lbs-in
60" X 36"	Class I	Class I	Class I	18 lbs-in

Air leakage is based on operation between 50°F to 104°F. All data corrected to represent air density of 0.075 lbs/ft.<sup>3</sup>

\*Torque applied to hold damper in closed position

## Imperial Units (Back Flow)

Damper Width X Height	1 in. w.g. Class	4 in. w.g. Class	8 in. wg Class	*Torque (per sq. ft.)
12" x 12"	Class I	Class I	Class I	18 lbs-in
24" X 24"	Class I	Class I	Class I	15 lbs-in
36" X 36"	Class I	Class I	Class I	18 lbs-in
12" X 48"	Class II	Class II	Class II	15 lbs-in
48" X 12"	Class I	Class I	Class I	15 lbs-in
60" X 36"	Class I	Class II	Class I	18 lbs-in

\*Torque applied to hold damper in closed position

		Leakage, ft <sup>3</sup> /min <sup>2</sup> /ft			
		Required Rating		Extended Ranges (optional)	
Class	Pressure	1"	4"	8"	12"
	I		4	8	11
II		10	20	28	35
III		40	80	112	140

All data corrected to represent standard air at a density of 0.075 lbs/ft.

NAH-720 SOUND RATINGS								
Damper Size	Damper Full Open		Damper 75% Open		Damper 50% Open		Damper 25% Open	
	CFM	NC	CFM	NC	CFM	NC	CFM	NC
12 x 12	2000	16	1500	11	1000	11	500	*
	3000	28	2250	21	1500	18	750	*
	4000	36	3000	29	2000	24	1000	*
18 x 18	2250	17	1688	10	1125	21	563	*
	4500	33	3375	26	2250	31	1125	*
	6750	43	5063	37	3375	40	1688	15
24 x 24	4000	11	3000	10	2000	26	1000	*
	8000	33	6000	29	4000	37	2000	21
	12000	43	9000	42	6000	46	3000	31

NC = Noise criteria in Decibels is based on room effect and 10db of room attenuation.  
\* = Less than 10 NC

## AMCA Test Figures

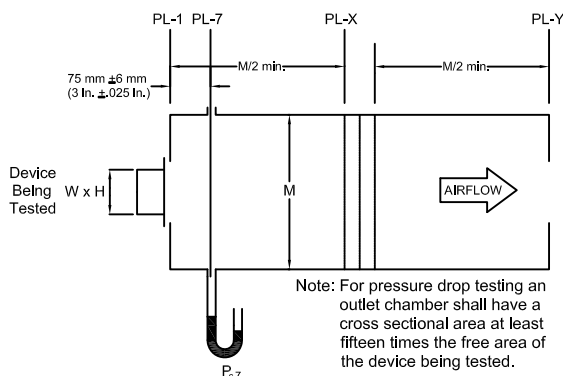

Figure 5.4- Test Device Setup with Outlet Chamber

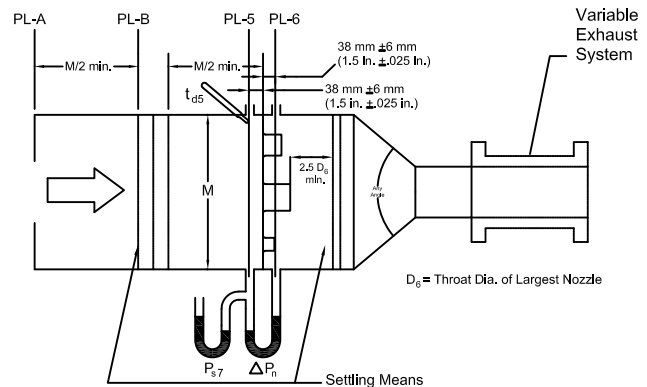

Figure 6.3- Airflow Rate Measurement Setup- Multiple Nozzle Chamber on Fan Inlet

# MODEL NAH-721-4 PERFORMANCE DATA

## Standard International Units (Forward Flow)

Damper Width X Height (mm)	250 Pa Class	1 KPa Class	2 KPa Class	*Torque
305 x 305	Class I	Class I	Class I	3,214 grams-cm
610 X 610	Class I	Class I	Class I	2,679 grams-cm
915 X 915	Class I	Class I	Class I	3,214 grams-cm
305 X 1220	Class I	Class I	Class I	2,679 grams-cm
1220 X 305	Class I	Class I	Class I	2,679 grams-cm
1525 X 915	Class I	Class I	Class I	3,214 grams-cm

Air leakage is based on operation between 10°C to 40°C. All data corrected to represent air density of 1.201 kg/m<sup>3</sup>.

\*Torque applied to hold damper in closed position

## Standard International Units (Back Flow)

Damper Width X Height (mm)	250 Pa Class	1 KPa Class	2 KPa Class	*Torque
305 x 305	Class I	Class I	Class I	3,214 grams-cm
610 X 610	Class I	Class I	Class I	2,679 grams-cm
915 X 915	Class I	Class I	Class I	3,214 grams-cm
305 X 1220	Class II	Class II	Class II	2,679 grams-cm
1220 X 305	Class I	Class I	Class I	2,679 grams-cm
1525 X 915	Class I	Class II	Class I	3,214 grams-cm

\*Torque applied to hold damper in closed position

		Leakage, L/s /m <sup>2</sup>			
		Required Rating		Extended Ranges (optional)	
Class	Pressure	0.25 kPa	1.0 kPa	2.0 kPa	3.0 kPa
I		20.3	40.6	55.9	71.1
II		50.8	102	142	178
III		203	406	569	711

## FRAME CONSTRUCTION OPTIONS

Flange (F Dim): Standard- 2"

Optional - 1-1/2" to 4"

Bolt holes: (Standard construction is **no** bolt holes)

Dim. "M": 7/16" dia. hole

Dim. "L": 6" Center to Center

Web (D Dim): Standard - 8"

Optional - 8" to 12"

**Note:** Customer must be within Min. or Max limits on table below.

Dim.	Min or Max	Standard	Description
<b>J</b>	min. 3/4"		First/Last Space in <u>Head/Sill</u>
<b>N1</b>	min. 1.0"		No. of holes in <u>Head/Sill</u>
<b>K</b>	min. F/2"		First/Last Space in <u>Jamb</u>
<b>N2</b>	min. 1.0"		No. of holes in <u>Jamb</u>
<b>C</b>	.75*D" to 3/4"	F/(2*M)"	Centerline of bolt hole from inside edge of frame
<b>L</b>	2" to 12"	6.0"	Hole Spacing
<b>M</b>	1/4" to 11/16"	7/16"	Mounting hole Diameter

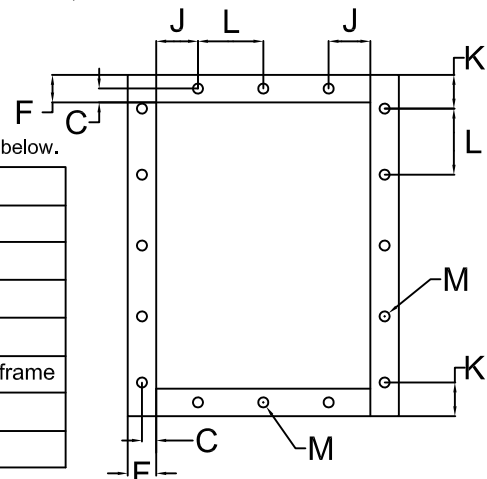

# MODEL NAH-721-4 PERFORMANCE DATA

## PRESSURE DROP

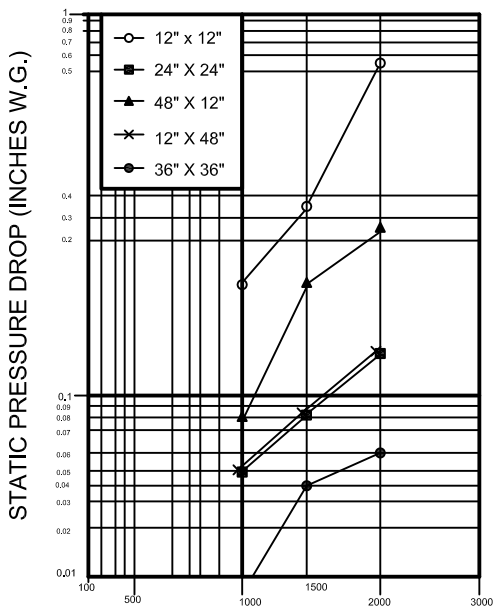

### Face Velocity (FT/MIN)

Based on STANDARD AIR- .075 lb. per cubic foot.

NAH-720-4 sizes: 12x12, 24x24, 48x12, 12x48, 36x36  
(305x305, 610x610, 1219x305, 305x1219, 914x914)

### NAH-720-4

#### PRESSURE LIMITATIONS

The chart at the right shows conservative pressure limitations based on a maximum blade deflection of w/360.

#### TEMPERATURE LIMITATIONS

Blade Seals: EPDM -40° to +250°F  
Silicone Rubber -40° to +450°F  
Jamb Seals: Flexible stainless steel -40° to +400°F

#### VELOCITY LIMITATIONS

The chart at the right shows conservative velocity limitations based on damper size.

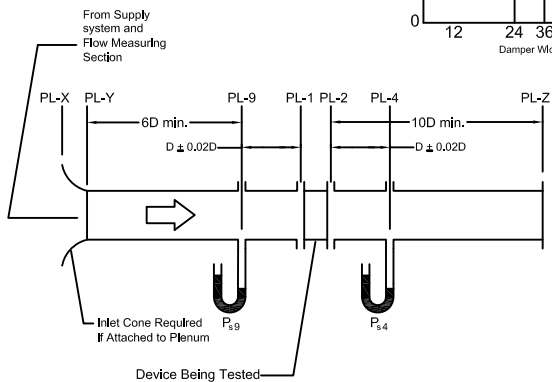
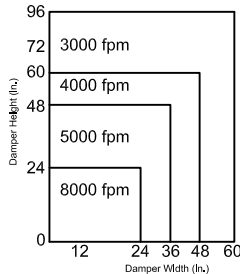
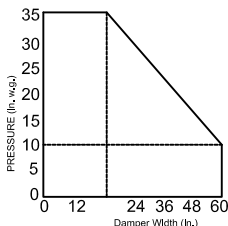

Figure 5.3- Test Device Setup with Inlet and Outlet Ducts

### AMCA Test Figure 5.3

Figure 5.3 illustrates a fully ducted damper. This configuration has low pressure drop because entrance and exit losses are minimized by straight duct runs upstream and downstream of the damper.

### Pressure Drop Data

This pressure drop data was conducted in accordance with AMCA Standard 500 using Test Figure 5.3. All data has been corrected to represent standard air at a density of .075 lb/cu.ft.

Actual pressure drop found in any HVAC system is a combination of many factors. This pressure drop information along with an analysis of other system influences should be used to estimate actual pressure losses for a damper installed in a given HVAC system.

12 x 12	
Face Velocity ft/min (m/s)	Pressure Drop in. w.g. (Pa)
1000 (5.08)	0.18 (45)
1500 (7.62)	0.35 (88)
2000 (10.16)	0.57 (144)

24 x 24	
Face Velocity ft/min (m/s)	Pressure Drop in. w.g. (Pa)
1000 (5.08)	0.05 (12)
1500 (7.62)	0.08 (20)
2000 (10.16)	0.13 (33)

48 x 12	
Face Velocity ft/min (m/s)	Pressure Drop in. w.g. (Pa)
1000 (5.08)	0.08 (20)
1500 (7.62)	0.18 (45)
2000 (10.16)	0.26 (66)

12 x 48	
Face Velocity ft/min (m/s)	Pressure Drop in. w.g. (Pa)
1000 (5.08)	0.05 (12)
1500 (7.62)	0.08 (20)
2000 (10.16)	0.13 (33)

36 x 36	
Face Velocity ft/min (m/s)	Pressure Drop in. w.g. (Pa)
1000 (5.08)	0.011 (3)
1500 (7.62)	0.04 (10)
2000 (10.16)	0.06 (15)

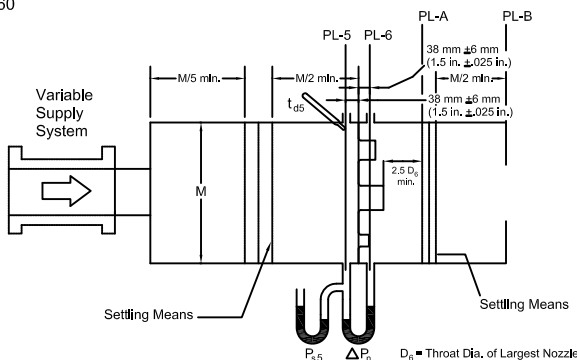

Figure 6.5- Airflow Rate Measurement Setup- Multiple Nozzle Chamber on Fan Outlet



**Pressure Drop Data**

The HVAC system has many factors that effect its internal pressure losses. Dampers in the system is one contributing factor. These dampers have been tested per AMCA Standard 500-D, Fig. 5.3 (ductwork upstream and downstream). There are many influences the ductwork configuration that could effect the performance below such as other objects close to the dampers, elbows or turns near the dampers, internally mounted actuators, etc. This data will assist the designer in the analysis of the system.

Pressure Drop  
12" dia. Damper

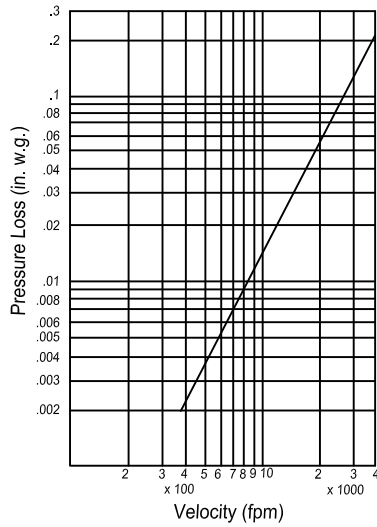

Pressure Drop  
36" dia. Damper

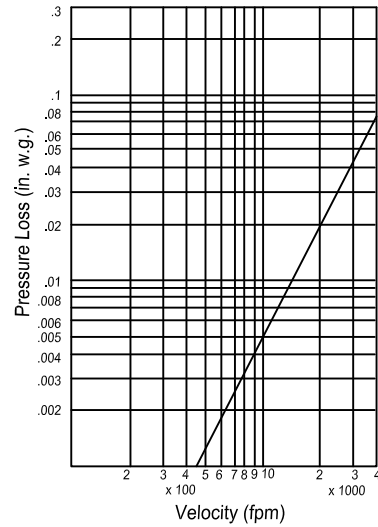

**Leakage Data**

The damper leakage shown below is per AMCA Standard 500-D . The leakage shown is without seals (standard construction) and with seals, crosslink closed cell or silica/woven. The damper is in the fully closed position.

Leakage  
12" Diameter Damper

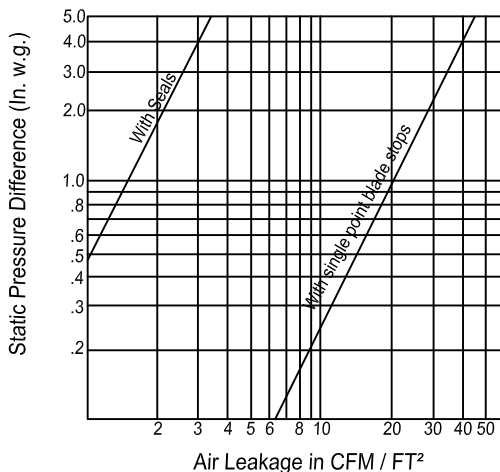

Leakage  
36" Diameter Damper

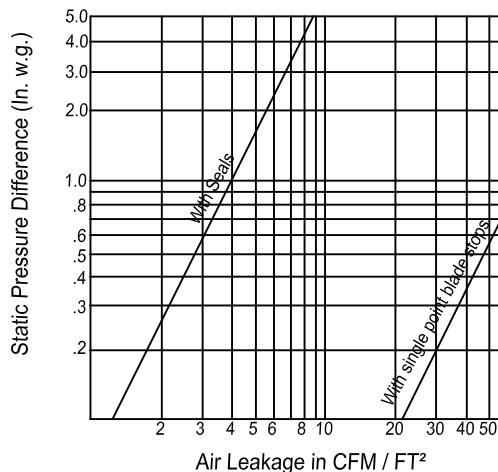

**Pressure Drop Data**

The HVAC system has many factors that effect its internal pressure losses. Dampers in the system is one contributing factor. These dampers have been tested per AMCA Standard 500-D, Fig. 5.3 (ductwork upstream and downstream). There are many influences the ductwork configuration that could effect the performance below such as other objects close to the dampers, elbows or turns near the dampers, internally mounted actuators, etc. This data will assist the designer in the analysis of the system.

Pressure Drop  
12" dia. Damper

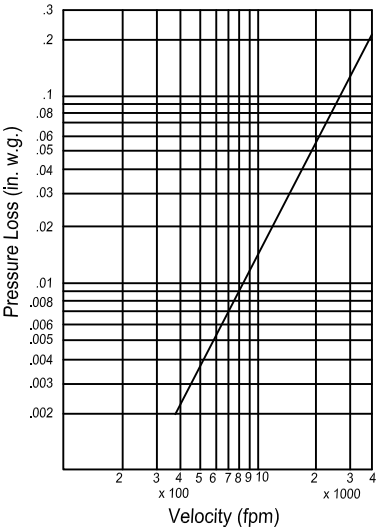

Pressure Drop  
36" dia. Damper

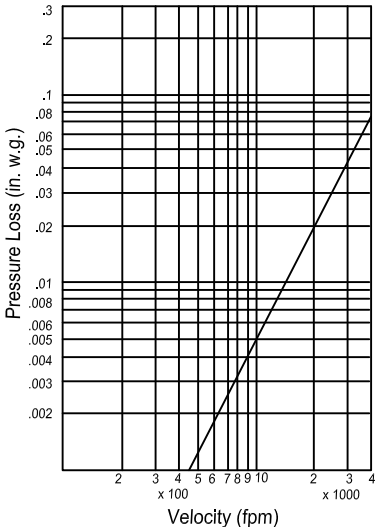

**Leakage Data**

The damper leakage shown below is per AMCA Standard 500-D . The leakge shown is without seals (standard contruction) and with seals, crosslink closed cell or silica/woven. The damper is in the fully closed position.

Leakage  
12" Diameter Damper

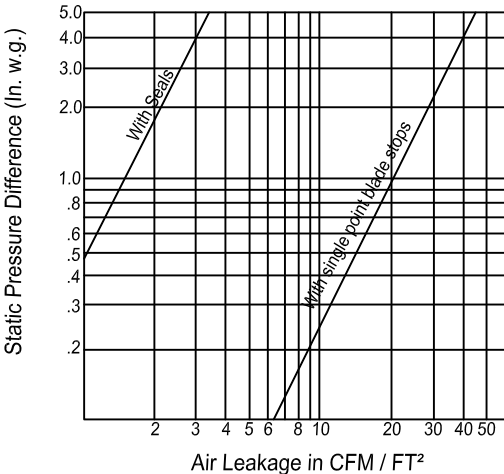

Leakage  
36" Diameter Damper

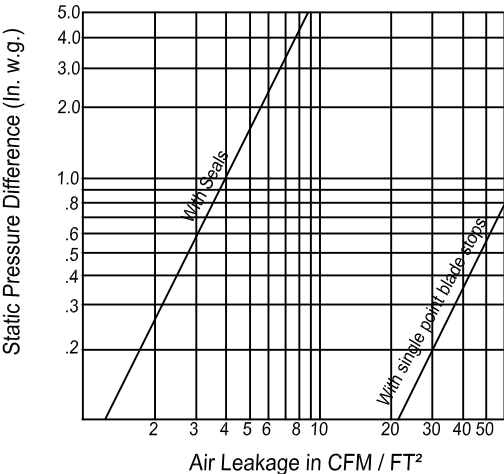

**Pressure Drop Data**

The HVAC system has many factors that effect its internal pressure losses. Dampers in the system is one contributing factor. These dampers have been tested per AMCA Standard 500-D, Fig. 5.3 (ductwork upstream and downstream). There are many influences the ductwork configuration that could effect the performance below such as other objects close to the dampers, elbows or turns near the dampers, internally mounted actuators, etc. This data will assist the designer in the analysis of the system.

Pressure Drop  
12" dia. Damper

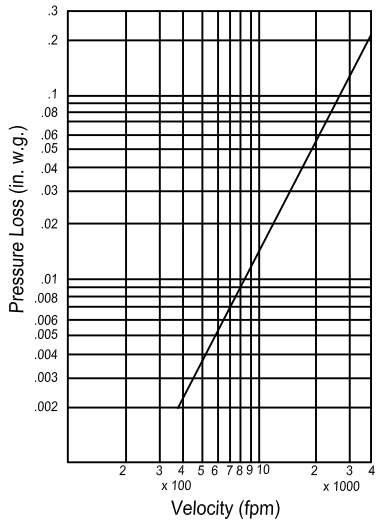

Pressure Drop  
36" dia. Damper

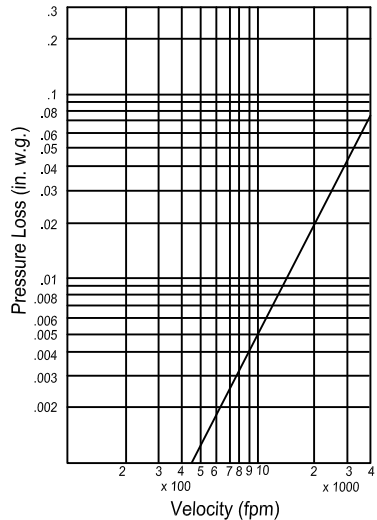

**Leakage Data**

The damper leakage shown below is per AMCA Standard 500-D . The leakage shown is without seals (standard contruction) and with seals, crosslink closed cell or silica/woven. The damper is in the fully closed position.

Leakage  
12" Diameter Damper

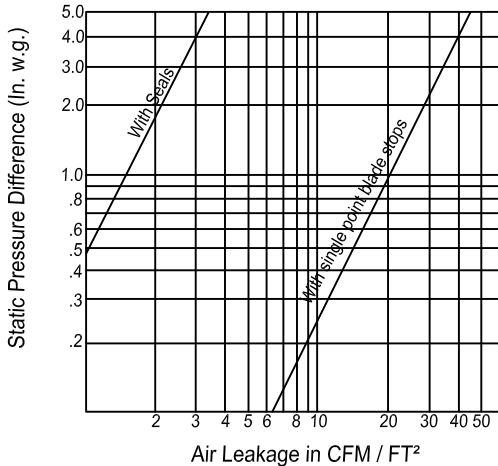

Leakage  
36" Diameter Damper

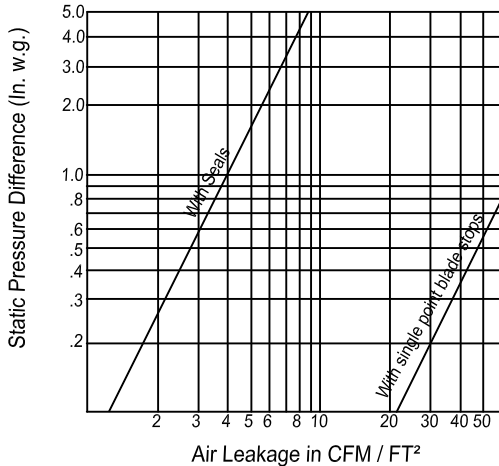

**Pressure Drop Data**

The HVAC system has many factors that effect its internal pressure losses. Dampers in the system is one contributing factor. These dampers have been tested per AMCA Standard 500-D, Fig. 5.3 (ductwork upstream and downstream). There are many influences the ductwork configuration that could effect the performance below such as other objects close to the dampers, elbows or turns near the dampers, internally mounted actuators, etc. This data will assist the designer in the analysis of the system.

Pressure Drop  
12" dia. Damper

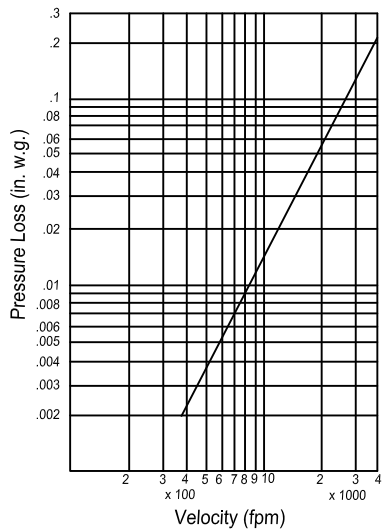

Pressure Drop  
36" dia. Damper

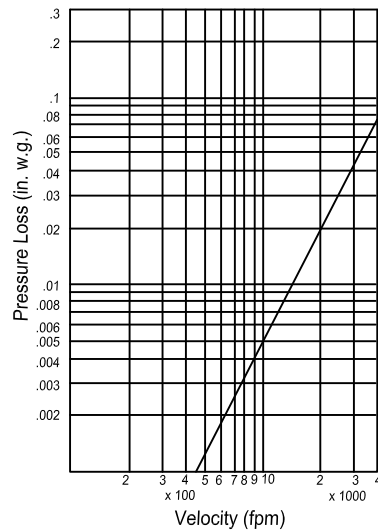

**Leakage Data**

The damper leakage shown below is per AMCA Standard 500-D . The leakage shown is with silicone seals (standard construction). The damper is in the fully closed position.

Leakage  
12" Diameter Damper

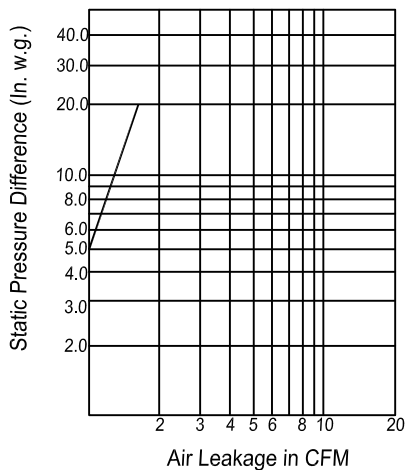

Leakage  
36" Diameter Damper

