

Louver Series

Sand Trap Louvers | Fixed Louvers | Acoustical Louvers
Wind - Driven Rain Louvers | Combination Louver/Damper
Adjustable Louvers



CVSA 
LOUVER SERIES

Sand Trap Louvers



CVSA 
LOUVER SERIES



MODEL STL 4.2-XT ULTRA LOW PRESSURE VERTICAL BLADE SAND TRAP LOUVER

STANDARD CONSTRUCTION:

Frame: 0.08" (2.00mm) Extruded Aluminum 6063 T6 or Galvanized Steel or Stainless Steel

Blade: 0.08" (2.00mm) Extruded Aluminum 6063 T6 or Galvanized Steel or Stainless Steel

Bird Screen: 0.75" x .051" Flattened Aluminum in removable frame. Screen is mounted as standard on inside (rear) as looking from exterior of building. Galvanized Steel or Stainless Steel screens are also available in various sizes.

Finish: Mill Aluminum (Std.)

Minimum Size: 12" x 12" (300mm x 300mm)

Maximum Section Size: 120" x 84" (3000 mm x 2100 mm) / 84" x 120" (2100 mm x 3000 mm)

OPTIONS:

- Galvanized Steel Construction
- Stainless Steel Construction
- Welded Construction (Wind Load +/- 50 psft)
- Heavy Gauge (Please consult for availability)
- Security Bars
- Filter Racks
- Bird Screen
- Washable Filter (1/2", 3/5", 1")
- Extended Sill (with Chute)
- Optional Flange (with Chute)



AVAILABLE FINISHES:

- Powder Polyester TGIC** (2 coats) baked on at 410°F, 2.5 to 3.5 mils Meets AAMA-2603 Standards
- Powder Super durable polyester** (2 coats) baked on at 410°F, 2.5 to 3.5 mils Meets AAMA-2604-05 Standards
- Acrylic baked enamel** (ACRA-BOND® ULTRA) by AkzoNobel baked on at 350°F, 0.8 to 1.2 mils dry Meets AAMA-2603 Standards
- Kynar®** (ALUM*A*STAR®) 2 coats by AkzoNobel baked on at 450°F, 1.2 to 1.6 mils dry Meets AAMA-2604-04 Standards
- Kynar 500®** or HYLAR® 5000 70% TRINAR® (2 coats) by AkzoNobel baked on at 450°F, 1.2 to 1.6 mils dry, Meets AAMA-2605-05 Standards OPTIONAL
- Kynar 500®** or HYLAR® 5000 (70% Tri-Escent II) (2 coats) by AkzoNobel, a superior finish to other metallic or anodized finishes. A blend of mica, ceramic, and inorganic pigments create subtle yet dazzling design that goes beyond metallic color without the requirement of a clear coat. 14 standard colors - custom colors available. Baked on at 415°F, 1.4 to 1.8 mils dry, meets AAMA 2605-05.
- Clear Anodize** 204 R-1 Class II (AA-C22A31)(0.4 to 0.7 mil)
- Clear Anodize** 215 R-1 Class I (AA-C22A41)(>0.7 mil)
- Integral Color Anodize** (AA-C22A42)(>0.7 mil)
- Clear coat available for all above finishes.
- Hylar® 5000 is a registered trademark of Solvay Solexis, Inc.
- Kynar® 500 is a registered trademark of Arkema.
- ALUM*A*STAR® 50 and TRINAR® are registered trademarks of AkzoNobel
- ACRA-BOND® ULTRA is a registered trademark of AkzoNobel

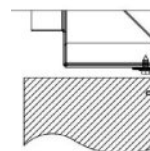
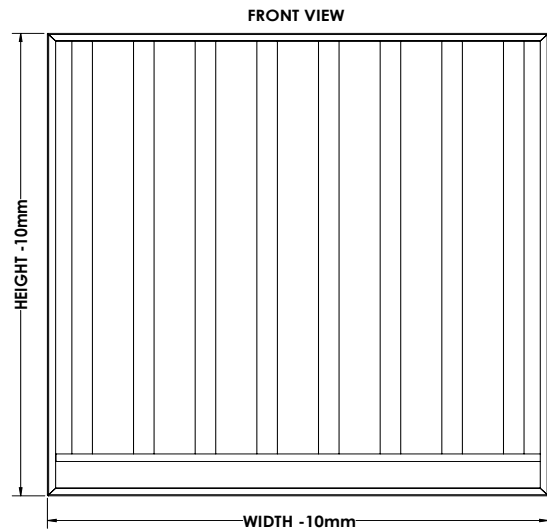
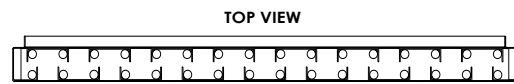
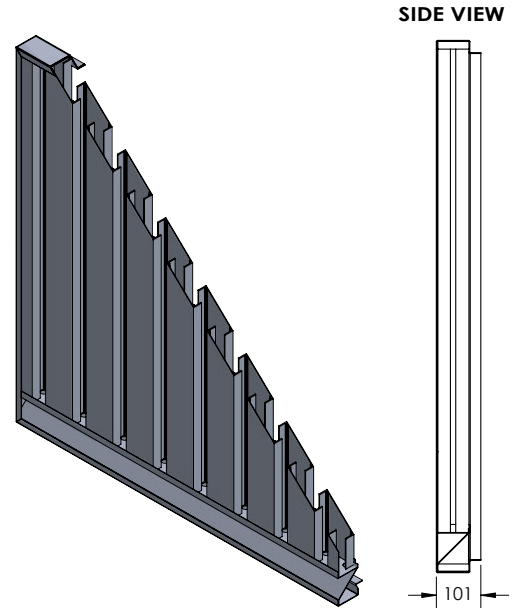

OPTIONAL FLANGE

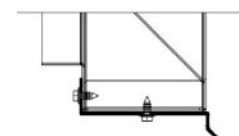

OPTIONAL EXTENDED SILL



Central Ventilation Systems
Al Wasit Road, P.O. Box 62547, Sharjah, UAE
T +971 6 533 6355 | F +971 6 533 3723
E cvsuae@eim.ae | www.cvshvac.com

MODEL STL 4.2-XT ULTRA LOW PRESSURE VERTICAL BLADE SAND TRAP LOUVER

Drawn By: DND	Approved BY: SB	REV. No.: 01	Date: March 2022	Cat ID: STL4.2-XT	Page: 1/4
------------------	--------------------	-----------------	---------------------	----------------------	--------------

WIND DRIVEN SAND PERFORMANCE GRAPH

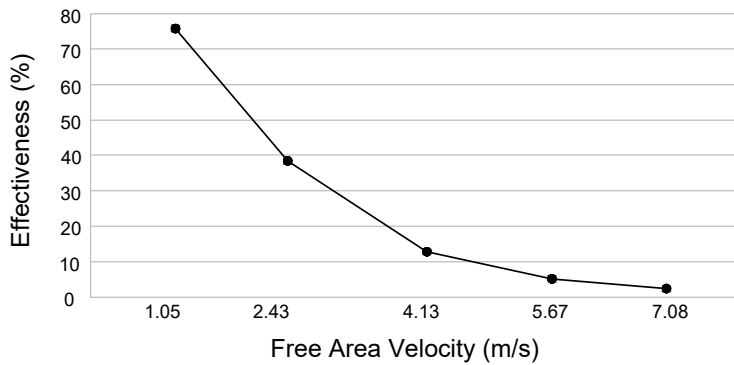

SAND REJECTION PERFORMANCE

Free Area Velocity(m/s) = Airflow rate(m³/s) / Free Area (m²)

Test No	Airflow Rate m ³ /s	Free Area Velocity (m/s)	Total Mass Injected g	Total mass Rejected g	Louver Effectiveness %
1	0.40	1.05	1000.3	761.2	76.10
2	0.94	2.43	1000.2	386.1	38.60
3	1.60	4.13	2000.7	257.8	12.89
4	2.19	5.67	2000.7	106.0	5.30
5	2.74	7.08	2000.9	47.2	2.36

Test Sample size is 48"x48" with a tolerance of +0, -0.25".
 Wind driven sand performance data is based on intake performance.
 Sand grade mass distribution per AMCA 511.

PRESSURE DROP GRAPH

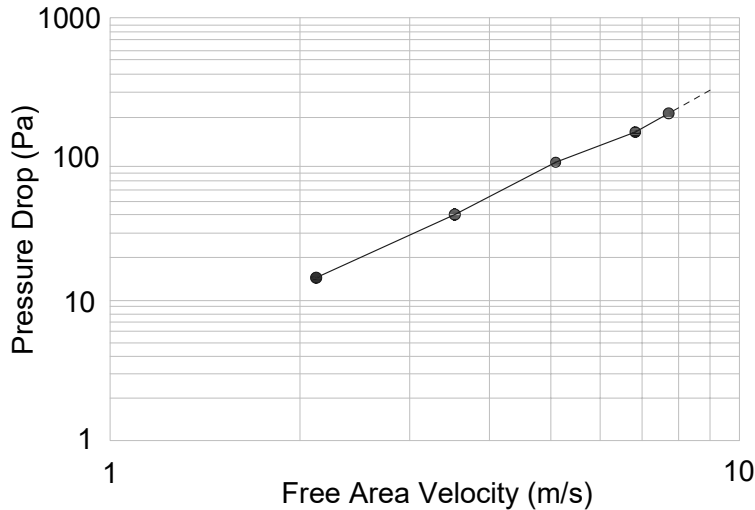

PRESSURE DROP OF LOUVER

Pressure Drop (Pa)	Airflow Rate (m ³ /s)	Free Area Velocity (m/s)
14.42	0.82	2.12
41.21	1.37	3.54
95.77	1.97	5.08
156.45	2.63	6.79
210.9	2.99	7.72

SUGGESTED SPECIFICATION

"Furnish and install louvers as hereinafter specified where shown on plans or as described in schedules. Louvers shall be stationary with fixed vertical blades formed or extruded and contained within a 3" frame. Where Duct Connection neck or filter rack is installed, frame shall be extended on the discharge side. Louver components (heads, jambs, sills, blades and mullions) shall be factory assembled by the louver manufacturer. Louver sizes too large for shipping shall be built by the contractor from factory assembled louver sections to provide overall sizes required. Louver design shall incorporate structural supports required to withstand a wind load of 30lbs. per sq.ft."

"Published louver performance bearing the AMCA Certified Ratings Seal for Air Performance & Wind Driven Sand must be submitted for approval prior to fabrication and must demonstrate pressure drop less than the CVS model specified. "

"Louver shall be model STL 4.2-XT, extruded Aluminum 6063-T6 construction as follows:
 Frame: 3" Deep, 0.08" nominal wall thickness with sand discharge points at the bottom
 Blades: 0.08" nominal wall thickness, blades are spaced at 2" apart"



Cat ID:	Rev. No.:	Date:	Page:
STL 4.2-XT	01	March 2022	2/4

FREE AREA CHART STL 4.2-XT

Height (H)	Width (W)																		
	12	18	24	30	36	42	48	54	60	66	72	78	84	90	96	102	108	114	120
12 in.	0.09	0.27	0.27	0.27	0.44	0.45	0.62	0.66	0.82	0.87	1.01	1.16	1.20	1.33	1.33	1.39	1.51	1.69	1.76
300 mm	0.01	0.02	0.02	0.02	0.04	0.04	0.06	0.06	0.07	0.08	0.09	0.09	0.10	0.12	0.12	0.12	0.14	0.15	0.15
18 in.	0.17	0.51	0.51	0.51	0.86	0.87	1.20	1.23	1.54	1.59	1.88	1.95	2.22	2.30	2.57	2.91	3.02	3.25	3.38
450 mm	0.02	0.05	0.05	0.05	0.08	0.08	0.11	0.11	0.14	0.14	0.17	0.17	0.20	0.20	0.23	0.26	0.26	0.30	0.30
24 in.	0.25	0.76	0.76	0.76	1.27	1.29	1.77	1.82	2.28	2.35	2.78	2.88	3.29	3.41	3.80	4.47	4.81	5.00	5.00
600 mm	0.02	0.07	0.07	0.07	0.12	0.16	0.16	0.21	0.21	0.25	0.25	0.30	0.30	0.35	0.35	0.39	0.44	0.44	0.44
30 in.	0.34	1.01	1.01	1.01	1.68	1.71	2.35	2.41	3.02	3.11	3.69	3.81	4.36	4.51	5.03	5.22	5.70	5.92	6.62
750 mm	0.03	0.09	0.09	0.09	0.15	0.21	0.21	0.21	0.27	0.27	0.34	0.34	0.40	0.40	0.46	0.52	0.52	0.58	0.58
900 mm	0.42	1.25	1.25	1.25	2.09	2.12	2.92	3.00	3.75	3.87	4.59	4.74	5.42	5.62	6.26	6.49	7.09	7.92	8.24
42 in.	0.50	1.50	1.50	1.50	2.50	2.54	3.49	3.58	4.49	4.63	5.49	5.68	6.49	6.72	7.49	7.77	8.48	9.48	9.66
1050 mm	0.05	0.14	0.14	0.14	0.23	0.32	0.32	0.32	0.41	0.41	0.50	0.50	0.59	0.59	0.68	0.68	0.77	0.87	0.87
48 in.	0.58	1.74	1.74	1.74	2.91	2.96	4.07	4.17	5.23	5.40	6.39	6.61	7.55	7.83	8.72	9.05	9.88	11.04	11.48
1200 mm	0.05	0.16	0.16	0.16	0.27	0.37	0.37	0.48	0.48	0.58	0.58	0.69	0.69	0.79	0.80	0.80	0.90	1.01	1.01
54 in.	0.66	1.99	1.99	1.99	3.32	3.38	4.64	4.76	5.97	6.16	7.29	7.54	8.62	8.93	9.95	10.32	11.27	12.60	13.10
1350 mm	0.06	0.18	0.18	0.18	0.30	0.42	0.42	0.42	0.54	0.54	0.67	0.67	0.79	0.79	0.91	0.91	1.03	1.15	1.15
60 in.	0.75	2.24	2.24	2.24	3.73	3.79	5.22	5.35	6.71	6.92	8.28	8.48	9.69	10.04	11.18	11.60	12.67	14.16	14.73
1500 mm	0.07	0.20	0.20	0.20	0.34	0.48	0.48	0.58	0.61	0.61	0.75	0.75	0.88	0.88	1.02	1.02	1.16	1.29	1.29
66 in.	0.83	2.48	2.48	2.48	4.14	4.21	5.79	5.94	7.44	7.68	9.10	9.41	10.75	11.14	12.41	12.88	14.06	15.72	16.35
1650 mm	0.08	0.23	0.23	0.23	0.38	0.53	0.53	0.53	0.68	0.68	0.83	0.83	0.98	0.98	1.13	1.13	1.28	1.44	1.44
72 in.	0.91	2.73	2.73	2.73	4.55	4.63	6.36	6.53	8.18	8.44	10.00	10.34	11.82	12.24	13.64	14.16	15.46	17.27	17.97
1800 mm	0.08	0.25	0.25	0.25	0.42	0.58	0.58	0.58	0.75	0.75	0.91	0.91	1.08	1.08	1.25	1.25	1.41	1.58	1.58
78 in.	0.99	2.97	2.97	2.97	4.96	5.05	6.94	7.12	8.92	9.20	10.90	11.28	12.89	13.35	14.87	15.43	16.85	18.83	19.59
1950 mm	0.09	0.27	0.27	0.27	0.45	0.63	0.63	0.63	0.81	0.81	1.00	1.00	1.18	1.18	1.36	1.36	1.54	1.72	1.72
84 in.	1.07	3.22	3.22	3.22	5.37	5.46	7.51	7.71	9.66	9.96	11.81	12.21	13.95	14.45	16.10	16.71	18.25	20.39	21.21
2100 mm	0.10	0.29	0.29	0.29	0.49	0.69	0.69	0.69	0.88	0.88	1.08	1.08	1.27	1.27	1.47	1.47	1.67	1.86	1.86
90 in.	1.16	3.47	3.47	3.47	5.78	5.88	8.09	8.30	10.40	10.73	12.71	13.14	15.02	15.56	17.37	17.92	19.83	22.11	22.97
2250 mm	0.11	0.32	0.32	0.32	0.53	0.74	0.74	0.74	0.95	0.95	1.16	1.16	1.37	1.37	1.57	1.57	1.77	1.97	1.97
96 in.	1.24	3.71	3.71	3.71	6.19	6.30	8.66	8.89	11.14	11.49	13.61	14.08	16.08	16.66	18.77	19.36	21.51	23.91	24.87
2400 mm	0.11	0.34	0.34	0.34	0.57	0.79	0.79	0.79	1.02	1.02	1.24	1.24	1.47	1.47	1.71	1.71	1.96	2.22	2.22
102 in.	1.32	3.96	3.96	3.96	6.60	6.72	9.24	9.48	11.87	12.25	14.51	15.01	17.15	17.77	19.97	20.57	22.82	25.32	26.37
2550 mm	0.12	0.36	0.36	0.36	0.60	0.84	0.84	0.84	1.08	1.08	1.33	1.33	1.57	1.57	1.82	1.82	2.07	2.33	2.33
108 in.	1.40	4.20	4.20	4.20	7.01	7.13	9.81	10.07	12.61	13.01	15.41	15.94	18.22	18.87	21.26	21.87	24.36	27.04	28.19
2700 mm	0.13	0.38	0.38	0.38	0.64	0.90	0.90	0.90	1.15	1.15	1.41	1.41	1.66	1.66	1.92	1.92	2.18	2.44	2.44
114 in.	1.48	4.45	4.45	4.45	7.42	7.55	10.38	10.65	13.35	13.77	16.32	16.87	19.28	19.98	22.47	23.17	25.75	28.52	29.77
2850 mm	0.14	0.41	0.41	0.41	0.68	0.95	0.95	0.95	1.22	1.22	1.49	1.49	1.76	1.76	2.03	2.03	2.30	2.57	2.57
120 in.	1.57	4.70	4.70	4.70	7.83	7.97	10.96	11.24	14.09	14.53	17.22	17.81	20.35	21.08	23.66	24.39	27.06	30.02	31.37
3000 mm	0.14	0.43	0.43	0.43	0.72	1.00	1.00	1.00	1.29	1.29	1.57	1.57	1.86	1.86	2.14	2.14	2.42	2.70	2.70

... Louvers will be manufactured in multi-section configuration for these highlighted sizes.



Central Ventilation Systems certifies that STL 4.2-XT shown herein is licensed to bear the AMCA Seal. The ratings shown are based on tests and procedures performed in accordance with AMCA Publication 511 and comply with the requirements of the AMCA Certified Ratings Program. The certified ratings seal applies to wind driven sand and air performance ratings.

LOUVER SERIES



Cat ID:	Rev No.:	Date:	Page:
STL 4.2-XT	01	March 2022	3/4





MODEL STL 4.2 ULTRA LOW PRESSURE VERTICAL BLADE SAND TRAP LOUVER

STL 4.2 is designed to protect air intakes from wind-driven sand with best in class air performance. Vertical sight proof blades separate sand from the airstream and offer high clearance from sand tray to prevent ingress of sand. STL4.2 is designed for the most demanding applications such as Fresh Air intakes for buildings, Air Handling Units, Generator Rooms with a focus on high air flow performance to minimize fan loading.

STANDARD CONSTRUCTION:

- Frame:** 0.08" (2.00mm) Extruded 6063 Extruded Aluminum or Formed
- Blade:** 0.06" (1.50mm) Extruded 6063 Extruded Aluminum or Formed
- Birdscreen:** 0.75" x .051" Flattened Aluminum in removable frame.
Screen is mounted as standard on inside (rear) as looking from exterior of building. Steel screens are also available in various sizes.

Finish: Mill Aluminum (Std.)

Minimum Size: 12" x 12" (300mm x 300mm)

Maximum Section Size: 120" x 120" (3000mm x 3000mm)

OPTIONS:

- Galvanized Steel Construction
- Stainless Steel Construction
- Welded Construction (Wind Load +/- 50 psf)
- Heavy Gauge (Please consult for availability)
- Security Bars
- Filter Racks
- Bird Screen
- Washable Filter (1/2", 3/5", 1")
- Extended Sil (with Chute)
- Optional Flange (with Chute)



AVAILABLE FINISHES:

- Powder Polyester TGIC** (2 coats) baked on at 410°F, 2.5 to 3.5 mils Meets AAMA-2603 Standards
- Powder Super durable polyester** (2 coats) baked on at 410°F, 2.5 to 3.5 mils Meets AAMA-2604-05 Standards
- Acrylic baked enamel** (ACRA-BOND® ULTRA) by AkzoNobel baked on at 350°F, 0.8 to 1.2 mils dry Meets AAMA-2603 Standards
- Kynar®** (ALUM*A*STAR®) 2 coats by AkzoNobel baked on at 450°F, 1.2 to 1.6 mils dry Meets AAMA-2604-04 Standards
- Kynar 500®** or **HYLAR® 5000 70% TRINAR®** (2 coats) by AkzoNobel baked on at 450°F, 1.2 to 1.6 mils dry, Meets AAMA-2605-05 Standards **OPTIONAL OPTIONAL**
- Kynar 500®** or **HYLAR® 5000 (70% Tri-Escnt II)** (2 coats) by AkzoNobel, a superior finish to other metallic or anodized finishes. A blend of mica, ceramic, and inorganic pigments creates subtle yet dazzling design that goes beyond metallic color without the requirement of a clear coat. 14 standard colors - custom colors available. Baked on at 415°F, 1.4 to 1.8 mils dry, meets AAMA 2605-05.
- Clear Anodize 204 R-1 Class II** (AA-C22A31)(0.4 to 0.7 mil)
- Clear Anodize 215 R-1 Class I** (AA-C22A41)(>0.7 mil)
- Integrat Color Anodize** (AA-C22A42)(>0.7 mil)
- Clear coat available for all above finishes.
- Hylar® 5000 is a registered trademark of Solvay Solexis, Inc.
- Kynar® 500 is a registered trademark of Arkema.
- ALUM*A*STAR® 50 and TRINAR® are registered trademarks of AkzoNobel
- ACRA-BOND® ULTRA is a registered trademark of AkzoNobel

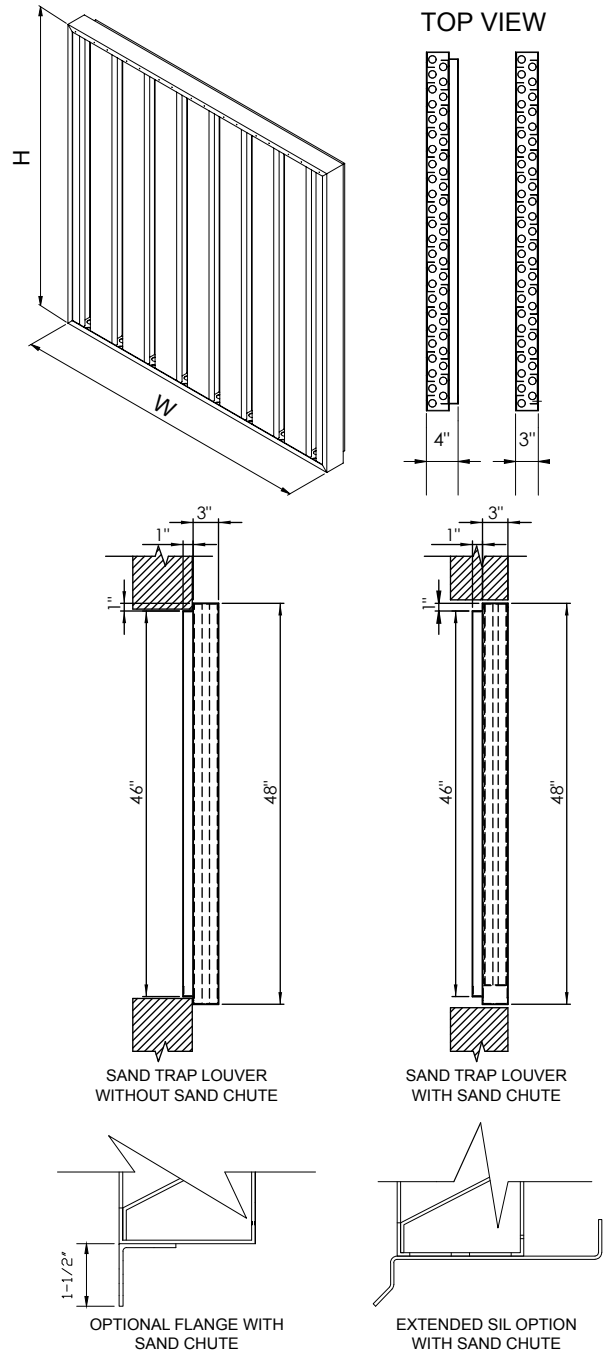

CVS Central Ventilation Systems
 Al Wasit Road, P.O. Box 62547, Sharjah, UAE
 T +971 6 533 6355 | F +971 6 533 3723
 E cvsuae@eim.ae | www.cvshvac.com

MODEL STL 4.2 ULTRA LOW PRESSURE VERTICAL BLADE SAND TRAP LOUVER

Drawn By: DND	Approved BY: SB	REV. No.: 00	Date: February 2021	Cat ID: STL4.2	Page: 1/2
------------------	--------------------	-----------------	------------------------	-------------------	--------------

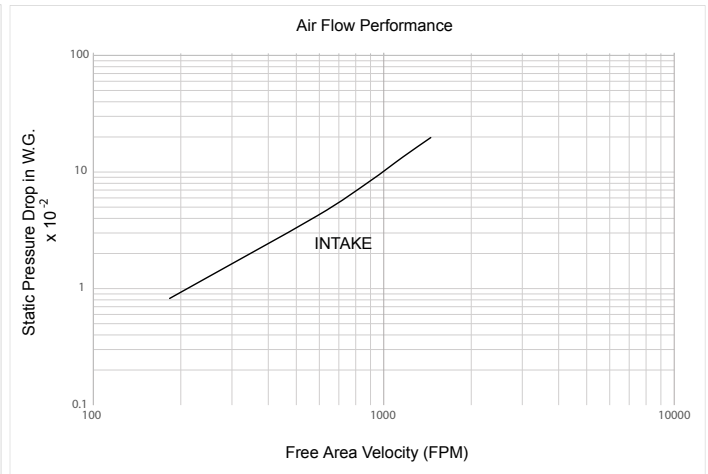
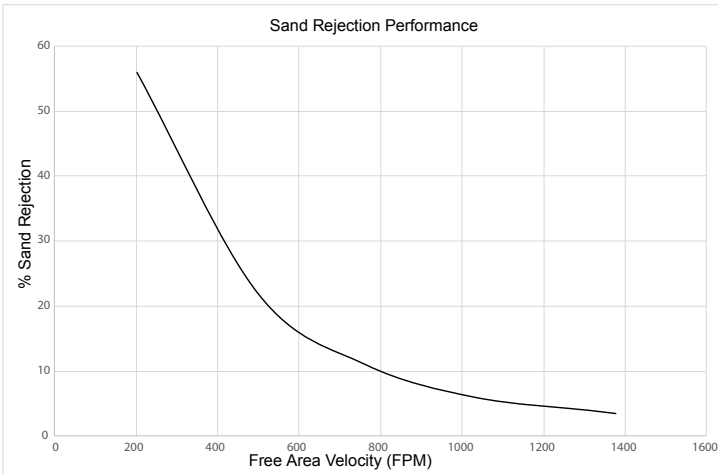

SAND REJECTION PERFORMANCE

Free Area Velocity (fpm)	197	492	787	1083	1378
Effectiveness (%)	56	21.5	10.5	5	3
Penetration Class	D	D	D	D	D

Test Sample size is 48"x48" with a tolerance of +0, -0.25".
 Wind driven sand performance data is based on intake performance.
 Sand grade mass distribution per AMCA 511.



Central Ventilation Systems certifies that STL4.2 shown herein is licensed to bear the AMCA Seal. The ratings shown are based on tests and procedures performed in accordance with AMCA Publication 511 and comply with the requirements of the AMCA Certified Ratings Program.

The certified ratings seal applies to wind driven sand and air performance ratings.

Tested for wind driven sand rejection in accordance with AMCA Standard 500-L, Figure 5.12.

FREE AREA CHART (SQF)

Louver Height (in)	Louver Width (in)																		Louver Height (in)	
	12	18	24	30	36	42	48	54	60	66	72	78	84	90	96	102	108	114		120
12	0.19	0.31	0.42	0.53	0.65	0.76	0.88	0.99	1.11	1.22	1.34	1.45	1.57	1.68	1.80	1.91	2.02	2.14	2.25	12
18	0.33	0.53	0.73	0.92	1.12	1.32	1.52	1.72	1.91	2.11	2.31	2.51	2.70	2.90	3.10	3.30	3.50	3.69	3.89	18
24	0.47	0.75	1.03	1.31	1.59	1.88	2.16	2.44	2.72	3.00	3.28	3.56	3.84	4.13	4.41	4.69	4.97	5.25	5.53	24
30	0.61	0.97	1.34	1.70	2.07	2.43	2.80	3.16	3.52	3.89	4.25	4.62	4.98	5.35	5.71	6.08	6.44	6.81	7.17	30
36	0.75	1.19	1.64	2.09	2.54	2.99	3.43	3.88	4.33	4.78	5.23	5.67	6.12	6.57	7.02	7.47	7.91	8.36	8.81	36
42	0.89	1.42	1.95	2.48	3.01	3.54	4.07	4.60	5.14	5.67	6.20	6.73	7.26	7.79	8.32	8.85	9.39	9.92	10.45	42
48	1.02	1.64	2.25	2.87	3.48	4.10	4.71	5.33	5.94	6.56	7.17	7.78	8.40	9.01	9.63	10.24	10.86	11.47	12.09	48
54	1.16	1.86	2.56	3.26	3.95	4.65	5.35	6.05	6.75	7.44	8.14	8.84	9.54	10.24	10.93	11.63	12.33	13.03	13.73	54
60	1.30	2.08	2.86	3.65	4.43	5.21	5.99	6.77	7.55	8.33	9.11	9.90	10.68	11.46	12.24	13.02	13.80	14.58	15.36	60
66	1.44	2.31	3.17	4.03	4.90	5.76	6.63	7.49	8.36	9.22	10.09	10.95	11.82	12.68	13.55	14.41	15.27	16.14	17.00	66
72	1.58	2.53	3.48	4.42	5.37	6.32	7.27	8.22	9.16	10.11	11.06	12.01	12.95	13.90	14.85	15.80	16.75	17.69	18.64	72
78	1.72	2.75	3.78	4.81	5.84	6.88	7.91	8.94	9.97	11.00	12.03	13.06	14.09	15.13	16.16	17.19	18.22	19.25	20.28	78
84	1.86	2.97	4.09	5.20	6.32	7.43	8.55	9.66	10.77	11.89	13.00	14.12	15.23	16.35	17.46	18.58	19.69	20.81	21.92	84
90	2.00	3.19	4.39	5.59	6.79	7.99	9.18	10.38	11.58	12.78	13.98	15.17	16.37	17.57	18.77	19.97	21.16	22.36	23.56	90
96	2.14	3.42	4.70	5.98	7.26	8.54	9.82	11.10	12.39	13.67	14.95	16.23	17.51	18.79	20.07	21.35	22.64	23.92	25.20	96
102	2.27	3.64	5.00	6.37	7.73	9.10	10.46	11.83	13.19	14.56	15.92	17.28	18.65	20.01	21.38	22.74	24.11	25.47	26.84	102
108	2.41	3.86	5.31	6.76	8.20	9.65	11.10	12.55	14.00	15.44	16.89	18.34	19.79	21.24	22.68	24.13	25.58	27.03	28.48	108
114	2.55	4.08	5.61	7.15	8.68	10.21	11.74	13.27	14.80	16.33	17.86	19.40	20.93	22.46	23.99	25.52	27.05	28.58	30.11	114
120	2.69	4.31	5.92	7.53	9.15	10.76	12.38	13.99	15.61	17.22	18.84	20.45	22.07	23.68	25.30	26.91	28.52	30.14	31.75	120

SUGGESTED SPECIFICATION

"Furnish and install louvers as hereinafter specified where shown on plans or as described in schedules. Louvers shall be stationary with fixed vertical blades formed or extruded and contained within a 3" frame. Where Duct Connection neck or filter rack is installed, frame shall be extended on the discharge side. Louver components (heads, jambs, sills, blades and mullions) shall be factory assembled by the louver manufacturer. Louver sizes too large for shipping shall be built by the contractor from factory assembled louver sections to provide overall sizes required. Louver design shall incorporate structural supports required to withstand a wind load of 30lbs. per sqf."

"Published louver performance bearing the AMCA Certified Ratings Seal for Air Performance & Wind Driven Sand must be submitted for approval prior to fabrication and must demonstrate pressure drop less than the CVS model specified. "

"Louver shall be model STL 4.2, 6063-T6 extruded Aluminum construction as follows:
 Frame: 3" Deep, 0.08" nominal wall thickness with sand discharge points at the bottom
 Blades: 0.06" nominal wall thickness, blades are spaced at 2" apart"

REV. No.: 00	Date: February 2021	Cat ID: STL4.2	Page: 2/2
-----------------	------------------------	-------------------	--------------



SAND TRAP LOUVER INSTALLATION INSTRUCTIONS

Flange Mount

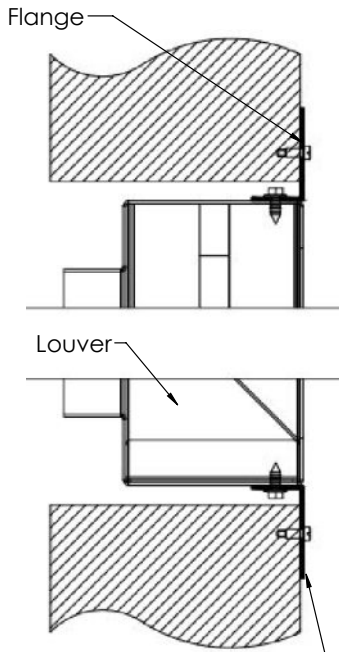

Attach louver sections together with L-Angle using suitable fasteners. **Fasteners are not supplied by CVS**

Masonry Wall

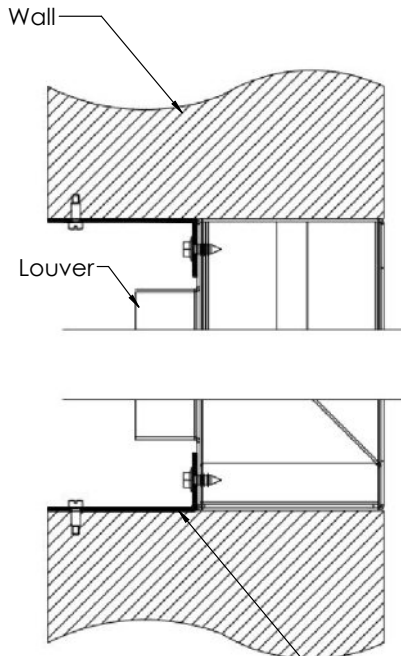

Attach louver sections together with L-Angle using suitable fasteners. **Fasteners are not supplied by CVS**

Extended Sill

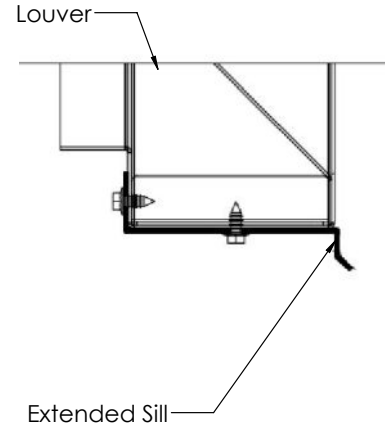

Multi-Section Assembly Plan View

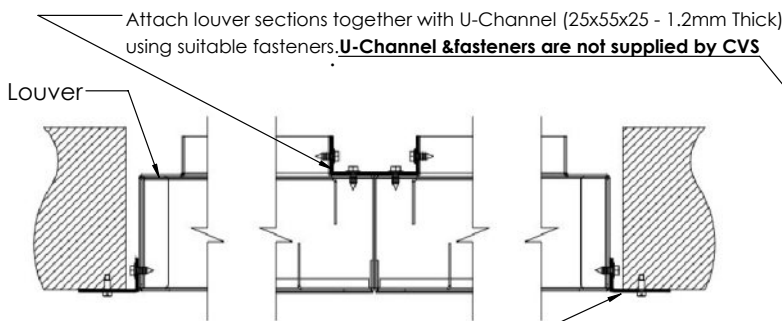

Attach louver sections together with L-Angle thru suitable fasteners. **Not supplied by CVS**

Multi-Section Assembly Elevation View

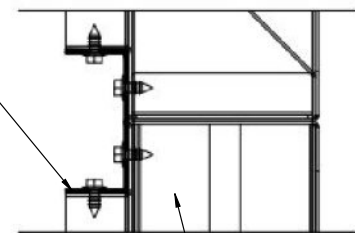

Notes:

- * **All the installation accessories and fasteners are not provided by CVS.**
- * Prior to installation, if the unit is to be stored on site, ensure it is stored in a clean & dry environment.
- * Don't stack excessive numbers of units as the weight of the stack may damage them.
- * Prior to installation, remove all packaging from the units.
- * **Central Ventilation Systems (CVS)** reserves the right to change specifications without notice.

Fixed Louvers



CVSA 
LOUVER SERIES

Fixed Louvers



EL-4
4" deep, fixed blade, extruded aluminum



EL-6
6" deep, fixed blade, extruded aluminum



FL-D-2
2" deep, fixed blade, drainable, extruded aluminum



FL-D-4
4" deep, fixed blade, drainable, extruded aluminum



FL-D-6.1
6" deep, high performance fixed louver, extruded aluminum



SFL-2
2" deep, fixed "J" blade, formed steel



SFL-4
4" deep, fixed "J" blade, formed steel



SFL-D-4
4" deep, fixed blade, formed steel, drainable

SFL-D-6
6" deep, fixed blade, formed steel, drainable

Model	Blade Angle	Blade Style	Blade	Material	FA*	fpm	CFM	W.C*	Sq. Ft.
EL-4	4.63	40°	J/K	.081 EA	53%	994	8369	.19	7.49
EL-6	6.2	45°	J	.125 EA	52%	834	6889	.12	8.26
FL-D-2	2.16	37°	Drainable	.060 EA	54%	805	6971	.09	8.66
FL-D - 4	4.19	37°	Drainable	.081 EA	50%	1250	10,025	.15	8.02
FL-D-6.1	6.2	37°	Drainable	.081 EA	54%	1250	10,888	.16	8.71
SFL-2	2.13	45°	J	18 ga. galv.					
SFL-4	4.13	45°	J	18 ga. galv.	47%	840	6342	.08	8.42
SFL-6	6	45°	J	18 ga. galv.	47%	896	6782	.14	7.57
SFL-D-4	4.13	45°	Drainable	18 ga. galv.	47%	1056	7888	.15	7.47
SFL-D-6	6.13	5°	Drainable	18 ga. galv.					

* Free area based on 48" x 48", pressure drop at 1,000 fpm.

MODEL FL-D-4 HIGH PERFORMANCE 4" FIXED LOUVER

STANDARD CONSTRUCTION:

Frame: 0.081" (2.00 mm) Extruded Aluminum, 4.19" (106 mm) Deep

Blade: 0.081" (2.00 mm) Extruded Aluminum positioned on a 37° angle on approximately 2.88" (73.15 mm) centers.

Birdscreen: 0.5" x .039" (12 mm x 1 mm) wire mesh or flattened aluminum. Screen is mounted as standard on inside (rear) as looking from exterior of building.

Finish: RAL 9010 (Std.). For other finishes, please contact the manufacturer.

Minimum Section Size: 12" x 12" (300 mm x 300 mm)

Maximum Single Section Size: 120" x 84" (3000 mm x 2100 mm) /
84" x 120" (2100 mm x 3000 mm)

OPTIONS:

- FBC Approved for +/- 50 PSF (FL 12335.1)
- Flanged Frame (1.50" std.)
- Custom Frame (1", 2", or 3"), (1.5", 2" , 3" for shapes R)
- Extended Sill
- Security Bars
- Filter Racks (No screen)
- Insect Screen (Other screens available)
- Glazing Adapter (0.50" or 0.75")
- Hinged Sub Frame
- Split Deflection 45°/ 0° blades
- Welded Construction (Wind load +/- 50 psf 0.125" (6 mm) construction
- Blank-off, Alum., non-insulated, no screen, non-removable
- Blank-off, Alum., non-insulated, with bird screen or insect screen
- Blank-off, Alum., insulated double wall, with bird screen, removable
- Blank-off, Alum., insulated double wall, no screen, non-removable

AVAILABLE FINISHES:

- Powder Polyester TGIC** (2 coats) baked on at 410°F, 2.5 to 3.5 mils Meets AAMA-2603 Standards
- Powder Super durable polyester** (2 coats) baked on at 410°F, 2.5 to 3.5 mils Meets AAMA-2604-05 Standards
- Acrylic baked enamel** (ACRA-BOND® ULTRA) by AkzoNobel baked on at 350°F, 0.8 to 1.2 mils dry Meets AAMA-2603 Standards
- Kynar®** (ALUM*A*STAR®) 2 coats by AkzoNobel baked on at 450°F, 1.2 to 1.6 mils dry Meets AAMA-2604-05 Standards
- Kynar 500®** or HYLAR® 5000 70% TRINAR® (2 coats) by AkzoNobel baked on at 450°F, 1.2 to 1.6 mils dry, Meets AAMA-2605-05 Standards
- Kynar 500®** or HYLAR® 5000 (70% Tri-ESCENT II) (2 coats) by AkzoNobel, a superior finish to other metallic or anodized finishes. A blend of mica, ceramic, and inorganic pigments creates subtle yet dazzling design that goes beyond metallic color without the requirement of a clear coat. 14 standard colors - custom colors available. Baked on at 415°F, 1.4 to 1.8 mils dry, meets AAMA 2605-05.
- Clear Anodize** 204 R-1 Class II (AA-C22A31)(0.4 to 0.7 mil)
- Clear Anodize** 215 R-1 Class I (AA-C22A41)(>0.7 mil)
- Integral Color Anodize** (AA-C22A42)(>0.7 mil)
- Clear coat available for all above finishes.
- Hylar® 5000 is a registered trademark of Solvay Solexis, Inc.
- Kynar® 500 is a registered trademark of Arkema.
- ALUM*A*STAR® 50 and TRINAR® are registered trademarks of AkzoNobel
- ACRA-BOND® ULTRA is a registered trademark of AkzoNobel

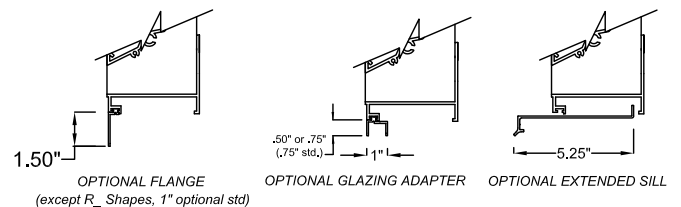
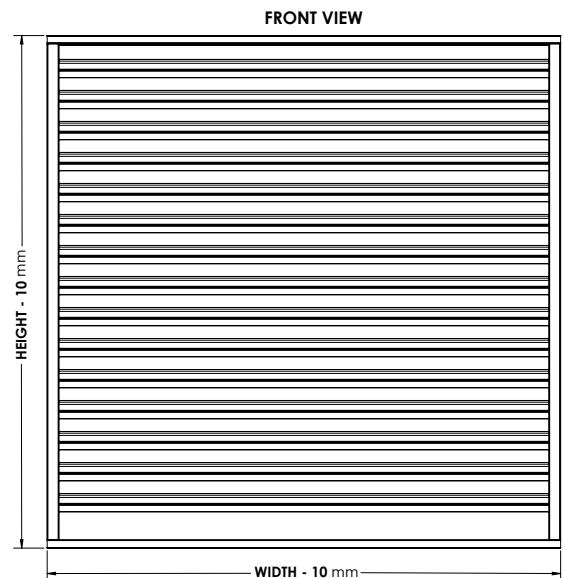
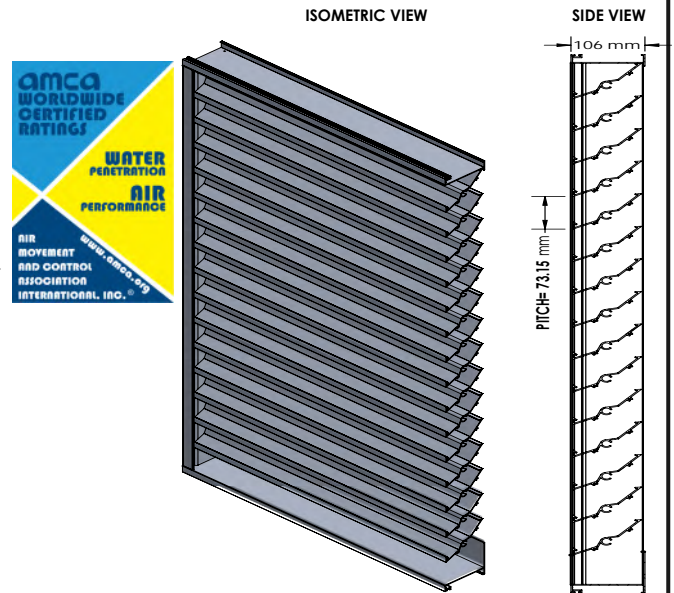

PRESSURE DROP - INTAKE

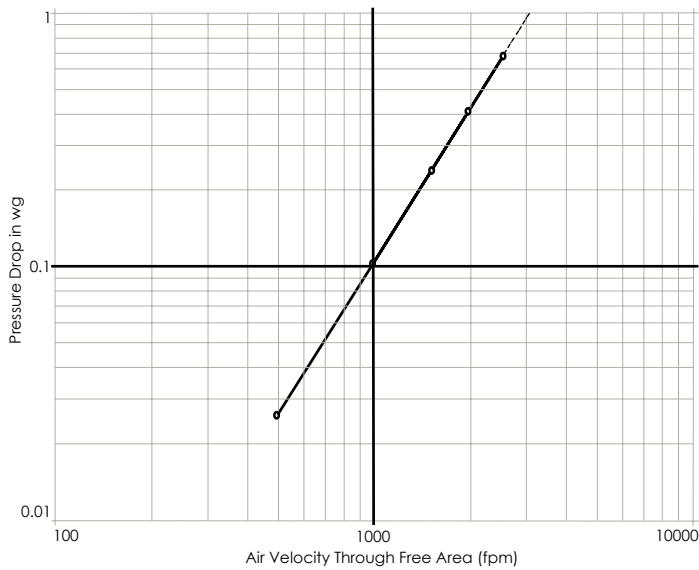

Tested in accordance with ANSI/AMCA 500-L, Figure 5.5
 Test sample size is 1220 mm x 1220 mm (48 in. x 48 in.)
 Air performance data are based on Intake performance with standard air - 0.075 lb/ft³

Detail No.	V _{Free Area} (fpm)	ΔP _{Ds} (in. wg)
1	2497	0.68
2	1989	0.43
3	1493	0.24
4	1001	0.11
5	499	0.03

PRESSURE DROP - EXHAUST

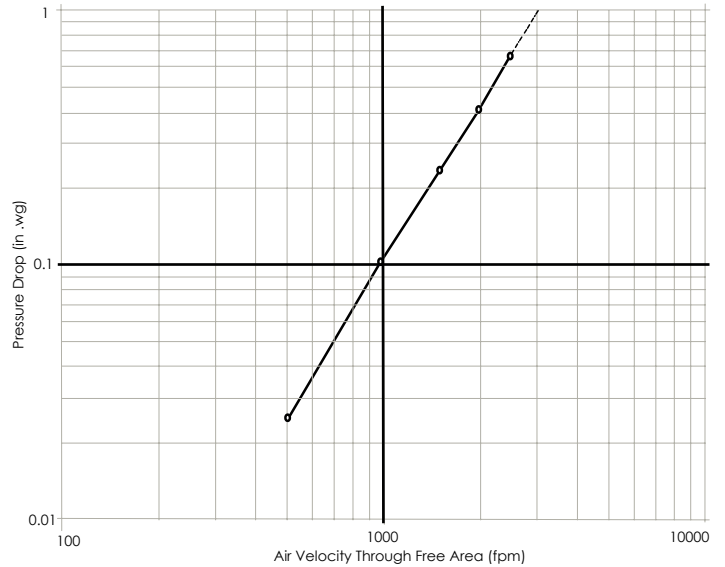

Tested in accordance with ANSI/AMCA 500-L, Figure 5.5
 Test sample size is 1220 mm x 1220 mm (48 in. x 48 in.)
 Air performance data are based on Exhaust performance with standard air - 0.075 lb/ft³

Detail No.	V _{Free Area} (fpm)	ΔP _{Ds} (in. wg)
1	2500	0.68
2	1992	0.41
3	1493	0.24
4	998	0.10
5	499	0.02

WATER PENETRATION

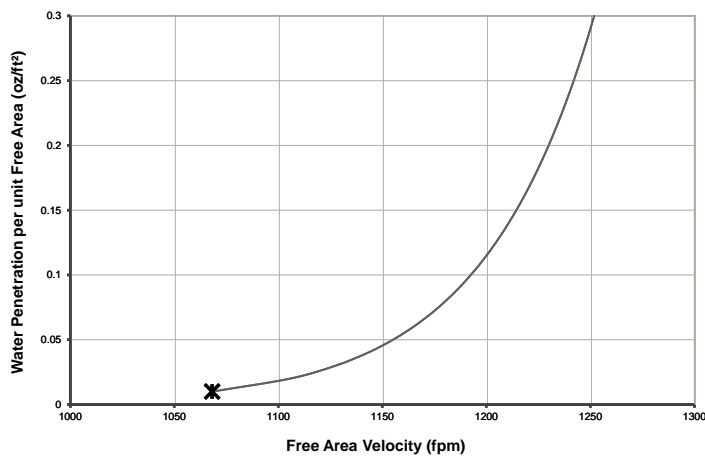

— Water Penetration of CVS FL-D-4 X Beginning of Water Penetration

Test sample size is 1220 mm x 1220 mm 48 in. x 48 in.
 Beginning of water penetration per AMCA Publication 511 Section 8.3.2 based on AMCA measured free area: **1068.3 fpm**

Detail No.	V _{Free Area} (fpm)	Net Weight (oz./ft. ²)
1	927	0.001
2	1031	0.003
3	1083	0.016
4	1135	0.035

SUGGESTED SPECIFICATION

Furnish and install louvers as hereinafter specified where shown on plans or as described in schedules. Louvers shall be stationary drainable type with drain gutters in each blade and downspouts in jambs and mullions. Stationary drainable blades shall be contained within a 4.19" (106 mm) frame. Louver components (heads, jambs, sills, blades and mullions) shall be factory assembled by the louver manufacturer. Louver sizes too large for shipping shall be built by the contractor from factory assembled louver sections to provide overall sizes required.

Louvers shall be model CVS FL-D-4, 6063-T6 Aluminum construction as follows:

- FRAME: 4.19" (106 mm) deep, 0.081" (2 mm) nominal wall thickness.
- BLADES: 0.081" (2 mm) nominal wall thickness. Blades are positioned at 39° angle and spaced approx. 2.88" (73.15 mm) center to center.
- SCREEN: 0.5" x 0.039" (12 mm x 1 mm) wire mesh or flattened aluminium on the inside (rear).
- FINISH: Select finish specification from CVS Finishes brochure.

Published louver performance bearing the AMCA Certified Ratings Seal for Air Performance & Water Penetration must be submitted for approval prior to fabrication and must demonstrate pressure drop and water penetration equal to or less than the CVS model specified.

AMCA Standard 500 provides a reasonable basis for testing and rating louvers. Testing to AMCA 500-L is performed under a certain set of laboratory conditions. This does not guarantee that other conditions will not occur in the actual environment where louvers must operate. The louver system should be designed with a reasonable safety factor for louver performance to ensure protection from water carryover, design with a performance level somewhat below maximum desired pressure drop and 0.01 oz./sq/ ft. of water penetration.



FREE AREA CHART FL-D-4

Height (H)	Width (W)																		
	12	18	24	30	36	42	48	54	60	66	72	78	84	90	96	102	108	114	120
300 mm	12	18	24	30	36	42	48	54	60	66	72	78	84	90	96	102	108	114	120
450 mm	12	18	24	30	36	42	48	54	60	66	72	78	84	90	96	102	108	114	120
600 mm	12	18	24	30	36	42	48	54	60	66	72	78	84	90	96	102	108	114	120
750 mm	12	18	24	30	36	42	48	54	60	66	72	78	84	90	96	102	108	114	120
900 mm	12	18	24	30	36	42	48	54	60	66	72	78	84	90	96	102	108	114	120
1050 mm	12	18	24	30	36	42	48	54	60	66	72	78	84	90	96	102	108	114	120
1200 mm	12	18	24	30	36	42	48	54	60	66	72	78	84	90	96	102	108	114	120
1350 mm	12	18	24	30	36	42	48	54	60	66	72	78	84	90	96	102	108	114	120
1500 mm	12	18	24	30	36	42	48	54	60	66	72	78	84	90	96	102	108	114	120
1650 mm	12	18	24	30	36	42	48	54	60	66	72	78	84	90	96	102	108	114	120
1800 mm	12	18	24	30	36	42	48	54	60	66	72	78	84	90	96	102	108	114	120
1950 mm	12	18	24	30	36	42	48	54	60	66	72	78	84	90	96	102	108	114	120
2100 mm	12	18	24	30	36	42	48	54	60	66	72	78	84	90	96	102	108	114	120
2250 mm	12	18	24	30	36	42	48	54	60	66	72	78	84	90	96	102	108	114	120
2400 mm	12	18	24	30	36	42	48	54	60	66	72	78	84	90	96	102	108	114	120
2550 mm	12	18	24	30	36	42	48	54	60	66	72	78	84	90	96	102	108	114	120
2700 mm	12	18	24	30	36	42	48	54	60	66	72	78	84	90	96	102	108	114	120
2850 mm	12	18	24	30	36	42	48	54	60	66	72	78	84	90	96	102	108	114	120
3000 mm	12	18	24	30	36	42	48	54	60	66	72	78	84	90	96	102	108	114	120

--- Louvers will be manufactured in multi-section configuration for these highlighted sizes.



Central Ventilation Systems certifies that FL-D-4 shown herein is licensed to bear the AMCA Seal. The ratings shown are based on tests and procedures performed in accordance with AMCA Publication 511 and comply with the requirements of the AMCA Certified Ratings Program.

The AMCA Certified Ratings Seal applies to Air Performance and Water Penetration ratings.



LOUVER SERIES

Louver Installation Instructions

Masonry Wall

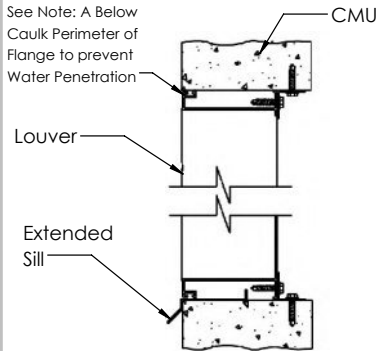

Metal Panel Wall

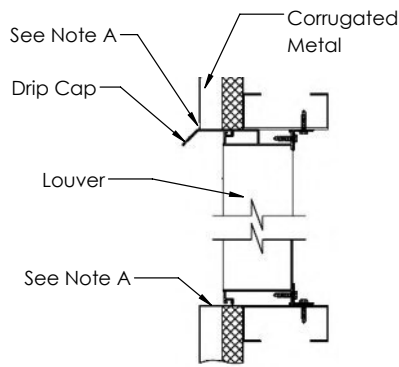

Wood Installation

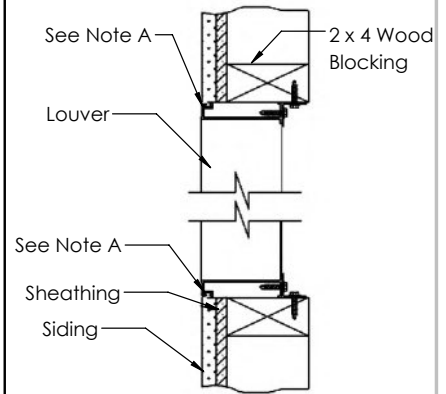

Flange Mount

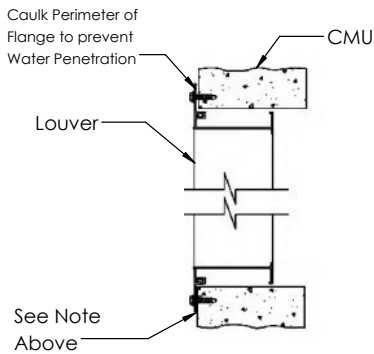

Angle Subframe

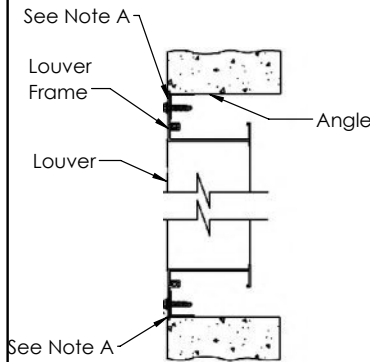

Suggested are (2) 7/32" diameter holes & (2) #10 x 5/8" sheet metal screws for angle attachment to louver. Not by CVS

To prevent corrosion, apply heavy coating of bituminous paint on any surface in contact with concrete, masonry or dissimilar metals

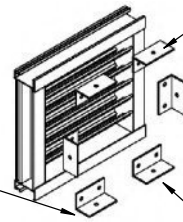

Holes for attachment to wall conditions drilled in field by customer. Anchor for your specific installation not supplied by CVS

Multi-Section Assembly / Plan View

Attach Louver Sections together with vertical angles or angle clips and min. #10sms, placed 12" max. o.c., $\Phi 3/8"$ thru bolts may also be used. Not Supplied by CVS

Holes for attachment to wall conditions drilled in field by customer. Anchors for your specific installation not supplied by CVS

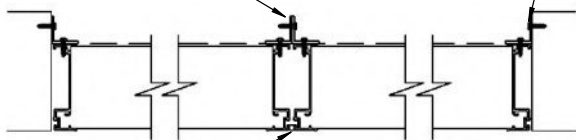

See Note A

Multi-Section Assembly / Elevation View

Optional: Attach louver sections together with horizontal angles or angle clips and min. #10 sms, placed 12" max. o.c., $\Phi 3/8"$ thru bolts may also be used. Not Supplied by CVS

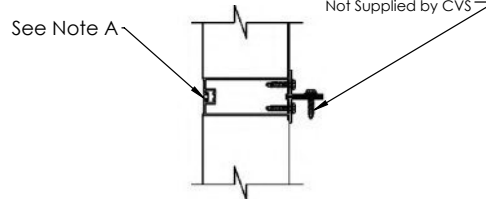

See Note A

Note A: After the louver is secured to the substrate, install backer rod and caulking (not provided by CVS) around the perimeter of the louver to the substrate and at section joints where possible. If mullion strips are provided, place caulk behind mullion strip (if possible) before attaching. If mullion strips already installed, apply a small bead where it touches the louver. Due to continuing research, **Central Ventilation Systems (CVS)** reserves the right to change specifications without notice.

Acoustical Louvers



CVSA 
LOUVER SERIES

Acoustical Louvers



XAC-4
8" deep acoustical louver, formed steel



XAC-6
12" deep acoustical louver, formed steel



XAC-9
12" deep acoustical louver, formed steel (variation in construction to XAC 6)



AXF-12
12" deep acoustical louver, airfoil blade, formed steel

AXF-8
8" deep acoustical louver, airfoil blade, formed steel

Model	Depth	Blade Style	Noise Reduction						FA	fpm	CFM	W.G
			125	250	500	1K	2K	4K				
XAC-4	8	Straight	6	4	7	12	14	10	28% 4.46	868	3871	.08
XAC-6	12	Straight	7	6	9	12	14	10				
XAC-9	12	Straight	8	8	13	17	16	12				
AXF-12	12	Straight	6	5	8	11	10	8				
AXF-8	8	Straight	12	11	12	13	13	13				

Wind - driven Rain Louvers

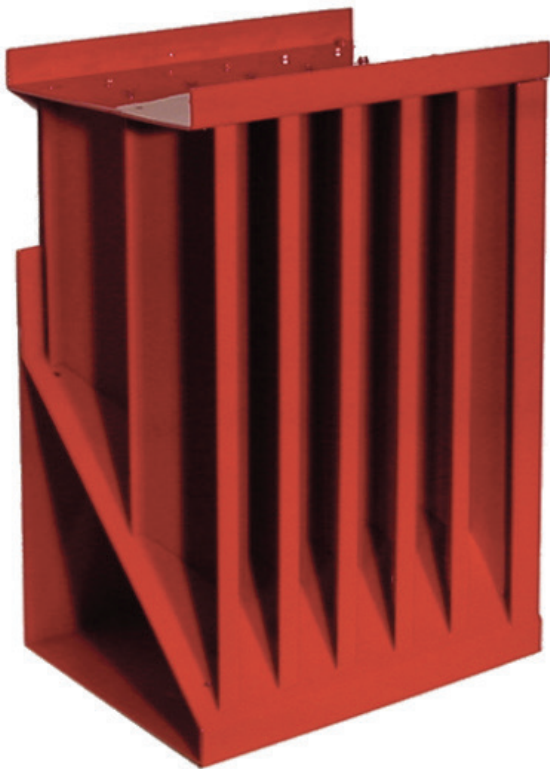

CVSA 
LOUVER SERIES

Wind-driven Rain Louvers



SED-4
4" deep, fixed blade,
drainable, wind/rain,
extruded aluminum



RD-4
4" deep, fixed vertical blade,
drainable, wind/rain,
extruded aluminum



RD-8
8" deep, fixed blade, drainable,
wind/rain/sand, extruded
aluminum



DHV-4
4" deep, fixed blade,
drainable, wind/rain,
extruded aluminum



XSD-130
5" deep wind driven
rain louver

Model Angle	Depth	Blade Style	FA sq.ft.	Wind Velocity	Rainfall (in/hr)	fpm Core	Effectiveness Ratio	Class	fpm	CFM	W.G.
SED-4	4.16	Drainable	35% 5.57	29,50	3,8	137	99.8	A	1086	6049	.21
RD-4	4.16	Vertical	40% 6.32	29,50	3,8	484	99.5	A	1000	6320	.35
RD-8	8.5	Sand/Rain	29% 4.58				99.9	A	940	4580	.13
DHV-4	4.16	Drainable	48% 7.75	29,50	3,8	974	99	A	1250	9688	.28
XSD-130	5.1	Drainable	46% 7.38	29,50	3,8	468	99.2	A	1000	7380	0.16

Combination Louver/Damper



CVSA 
LOUVER SERIES

Combination Louver/Damper



CFL-D-4
4" deep, drainable,
extruded aluminum



CFL-D-6
6" deep, drainable,
extruded aluminum

Model	Depth Angle	Blade Style	Blade	Material	FA sq. ft.	fpm	CFM	W.G
CFL-D-4	4.16	37°	Combo	.081 EA	46%	924	6754	.07
CFL-D-6	6.2	37°	Combo	.125 EA	47%	1250	9463	.11

Adjustable Louvers



CVSA 
LOUVER SERIES

Adjustable Louvers



SAFL-4
4" deep, adjustable, "J"
blade, formed steel



SAFL-6
6" deep, adjustable, "J"
blade, formed steel



AFL-D-4
4" deep, adjustable
blade, extruded
aluminum

AFL-D-6
6" deep, adjustable
blade, extruded
aluminum

Model	Depth Angle	Blade Style	Blade	Material	FA sq. ft.	fpm	CFM	W.G.
SAFL-4	4.13	45°	Adj/Drain	18 ga galv	47%	840	6342	.09
SAFL-6	6.13	45°	Adj/Drain	18 ga galv	47%	896	6783	.13
AFL-D-4	4.25	37°	Adj/Drain	.081 EA	43%	1217	8288	.11
AFL-D-6	6.2	37°	Adj/Drain	.081 EA	54%	922	7892	.08

Projects References



Projects References



Product Range

- ▶ Fire-Resisting Ductwork (BS & EN)
- ▶ Fire-rated Insulation (ASTM & UL)
- ▶ Sound Attenuators (ASTM & BS)
- ▶ VAV Boxes (AHRI)
- ▶ Life Safety Dampers (UL)
- ▶ Control Dampers (AMCA & BS)
- ▶ Access Doors (BS & EN)
- ▶ Louvers (AMCA)
- ▶ Smoke Exhaust, Building, Car Park & Tunnel Ventilation Fans (AMCA & EN)
- ▶ Domestic and Industrial Ventilation Fans
- ▶ AHU, FAHU, FCU, RTU, ERV & Ecology Units (Eurovent, TUV & AHRI)
- ▶ Electrostatic Precipitators (ESPs) & UL Listed Air Filters (UL)

Our Brands



Non-Coated Fire-Resisting Ductwork & Life Safety Dampers



Smoke Exhaust, Car Park & Tunnel Ventilation



Control Dampers, Louvers, Sound Attenuators & VAV Boxes



Fire-rated Insulation



Coated Fire-Resisting Ductwork



General Ventilation



AHU, FCU, RTU, ERV & Ecology Units

U.A.E

Industrial Area 2,
Al Wasit Road,
Sharjah, UAE

K.S.A

Dammam 2nd
Industrial City,
Dammam 31952,
K.S.A

Egypt

Al Minya Industrial Zone,
Al Minya Governorate
2427606, Egypt

Qatar

Street 9 Industrial Area,
Doha, Qatar



sales@cvshvac.com



www.cvshvac.com